

A Novel Broadband Compact 3dB 180° Power Divider/Combiner Derived From the Wilkinson Power Divider/Combiner

Oğuzhan Kızılbey¹, Osman Palamutçuoğulları² and Sıddık Binboğa Yarman³

¹Tubitak Bilgem, Kocaeli

oguzhan.kizilbey@tubitak.gov.tr

²Beykent University, Istanbul

opal@itu.edu.tr

³Istanbul University, Istanbul

sbyarman@gmail.com

Abstract

In this paper, a novel 3 dB 180° power divider/combiner is proposed. This device is derived from the classical Wilkinson divider/combiner whose output ports were combined with inverting and non-inverting suspended microstrip lines (SMLs). The proposed structure has a reduced size compared with the conventional and enhanced variants of the 3 dB 180° divider/combiner topologies. Moreover, the new architecture has a greatly improved bandwidth. The measured 0.5 dB insertion loss bandwidth is over the 2-5 GHz band for power combining/dividing. Because of its symmetrical architecture, the presented device shows frequency independent power dividing/combining balance performance. The maximum of 0.5 dB amplitude imbalance and 3° phase imbalance measured over frequency band of 2-5 GHz. Measured port isolation is also about 50 dB at the center frequency.

1. Introduction

The 3 dB 180° power divider/combiner is a three port device which works as the power divider/combiner in order to combine and divide the signals having 180° phase difference [1], [2]. It has several applications in the design of the frequency doublers, mixers and balanced power amplifiers [2]. The 180° power divider/combiner may be implemented in several forms and the ring hybrid structure is most popularly used in microwave circuits because of its simple design methodology [2]. The conventional ring hybrid is composed of three $\lambda/4$ (90°) and one $3\lambda/4$ (270°) transmission line sections. The major limiting factor in this structure in terms of both bandwidth and compactness is the $3\lambda/4$ transmission line section. The total circumference which has 1.5λ length is quite long especially for the low frequency applications and for the MMIC circuit realizations. Moreover, the operation bandwidth of the ring hybrid is very limited due to the length of $3\lambda/4$ section which presents the major phase variation with respect to the frequency.

Several methods have been proposed in order to decrease the frequency sensitivity and size of these structures. Commonly used methods consist of replacing the $3\lambda/4$ (270°) transmission line section with shorter structure with the same impedance, for instance, by a line with a phase-reversing element, providing 90° plus a frequency-independent 180° phase delay. This concept was originally presented by March in [3], where a pair of opposite-end short-circuited broadside coupled striplines

substitutes for the traditional section and approximates a phase-reversing network over a wide frequency range. In [4]–[9], the bandwidth enhancement is achieved by using the phase reversal. In addition to bandwidth enhancement, this approach reduces the length of circumference by $\lambda/2$. Moreover, in order to build this structure is a bit challenging because of the very small gap between the coupled lines. Realization of these circuits is almost impossible particularly for the frequencies above 2 GHz.

This paper proposes a novel 180° out-of-phase power divider/combiner derived from the Wilkinson divider where the output ports are combined with $\lambda/4$ phase inverting and non-inverting suspended microstrip lines (SMLs). Working and design principles of the SML structure is broadly explained in [10]. The implementation is realized by a combination of microstrip lines and suspended lines. Furthermore, the proposed 3 dB 180° out-of-phase divider/combiner is perfectly symmetric, which provides perfect amplitude and phase balances at all frequencies and provides perfect isolation between the output ports.

2. Design Procedure of 180° Divider/Combiner

The proposed 180° power divider/combiner is based on the classical Wilkinson divider/combiner. The Wilkinson divider/combiner is a broadband three port device which achieves in-phase power division or power combination [1], [2]. All of its ports are matched and isolated from one another. In the combination mode, isolation is achieved by dissipating the coupled power in the resistor connected between the two inputs. Conventionally, the symmetric power divider is used for in-phase power dividing/combining. A power divider with wideband 180° out-of-phase operation is needed for many balanced circuit such as a push-pull amplifier and balanced mixer. The 180° hybrid or the power divider with a 180° delay line is used for such purpose. A 180° divider can be easily realized by adding an extra section of delay line. However, a delay line limits the bandwidth of phase balances. The conventional 180° hybrid coupler or Wilkinson power divider with a delay line may not fulfill actual application demands and may degrade the system performance.

Specifically, the proposed 3 dB 180° divider/combiner is obtained from the conventional 3 dB Wilkinson divider/combiner by adding to the output ports $\lambda/4$ phase inverting and non-inverting suspended microstrip lines (SMLs), as shown in Fig. 1. The power applied to port-1 is equally divided between port-2 and port-3. These ports have 180° phase

difference because of the fact that port-2 has non-inverting SML and port-3 has inverting SML.

In the figure below, W_{50} and W_{70} are the width of the microstrip lines. For W_{50} , 0.5 mm; for W_{70} , 0.3 mm values are calculated by using AWR TxLine tool and these values are optimized with AWR. Final values are 0.53 mm and 0.27 mm for W_{50} and W_{70} , respectively. Length of the W_{70} line and SMLs are all at $\lambda/4$. The wavelength (λ) is calculated by taking (fC) center frequency 3.5 GHz. All the port impedances are designed at 50Ω .

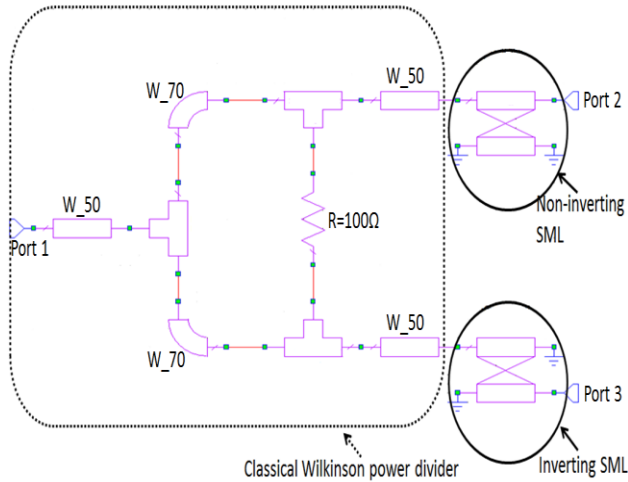

Fig. 1. Schematic of proposed divider/combiner.

3. Simulations and Measurement Results

The proposed circuit was implemented on a Rogers 5880 substrate with 2.2 of dielectric constant and 0.254 mm of thickness. The prototype is shown in Fig. 2. The prototype board is measured using standard 50Ω SMA connectors and a two-port Rohde-Schwarz ZVK Vector Network Analyzer (VNA) by connecting two of the ports while loading the other port with matched load. Fig. 3, 4 and 5 show the simulated and measured frequency response for all ports. The experimental results agree well with the simulations. From measurement results, the insertion loss from the input port (port-1) to port 2 and port 3 are 2.8 and 3.3 dB, respectively, at the center frequency 3.5 GHz. The measured 0.5-dB amplitude bandwidth is 85%. The insertion loss is mainly due to the microstrip line-SML transitions and radiation loss. The return loss of port-1 is shown in Fig. 3. Over the 2-5 GHz frequency band, return loss (S_{11}) is better than -10 dB. The isolation between output ports port-2 and port-3 is shown in Fig. 4. Over the band, isolation is better than -20 dB. Return loss of output ports are shown in Fig. 5. Over the 2-5 GHz band, return loss of port-2 and port-3 are better than -20 dB. At center frequency both of the ports have -40 dB return loss. Fig. 6 shows the simulated and measured frequency response of insertion phases from the port-1 to port-2 and port-3. The phase differences between the port-2 and port-3 is almost frequency-independent all over the frequency band.

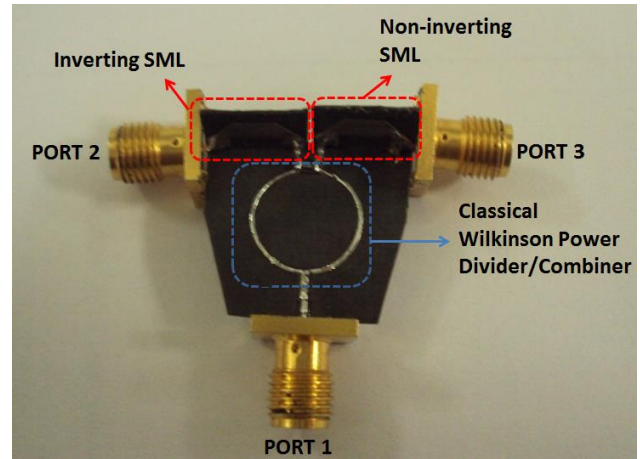

Fig. 2. Fabricated 180° power divider/combiner.

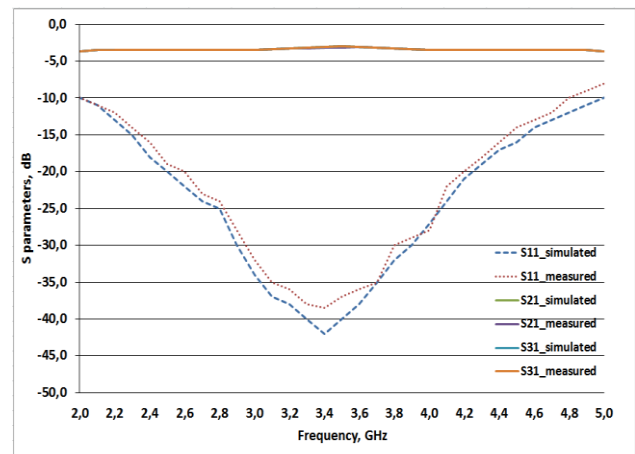

Fig. 3. Return loss of port-1 and insertion loss of port-2 and 3.

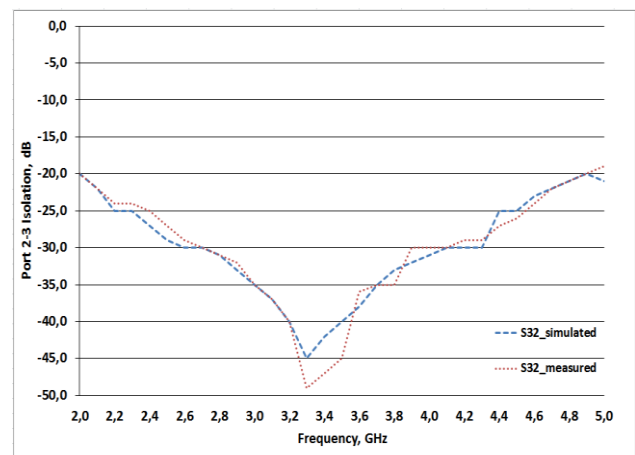

Fig. 4. Isolation between port-2 and port-3.

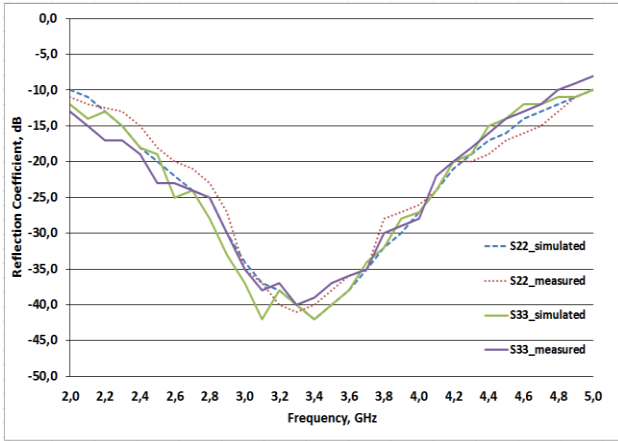

Fig. 5. Return loss of port-2 and port-3.

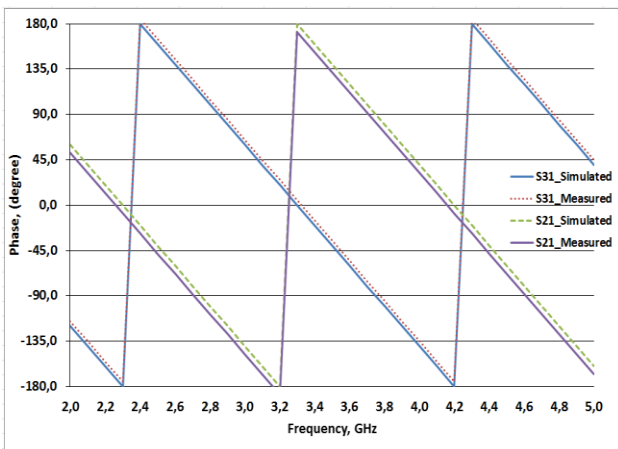

Fig. 6. Insertion phase from port-1 to port-2 and port-3.

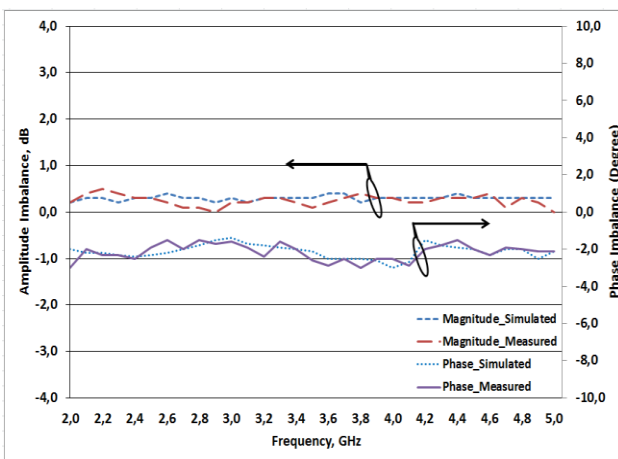

Fig. 7. Amplitude and phase imbalance for port-2 and port-3.

Fig. 7 shows the simulated and measured amplitude and phase imbalance performance for output ports. A measured maximum amplitude imbalance of 0.6 dB is achieved over a

bandwidth from 2 to 5 GHz and the measured maximum phase imbalance is 3° over the same bandwidth.

4. Conclusions

A novel 180° power divider/combiner has been presented. The contribution is to combine output ports of the in-phase Wilkinson power divider with inverting and non-inverting SMLs. The proposed structure has wide bandwidth, low insertion loss, high isolation between output ports and miniaturized circuit size. Because of its symmetric structure, frequency independent response is achieved and the measured isolation between output ports is minimum 20 dB over 2-5 GHz.

5. References

- [1] E. J. Wilkinson, "An N-way power divider," *IRE Trans. Microw. Theory Tech.*, vol. 8, no. 6, pp. 116-118, Jun 1968.
- [2] D. M. Pozar, *Microwave Engineering*, 3rd ed. Hoboken, NJ: Wiley, 2004.
- [3] S. March, "A wideband stripline hybrid ring," *IEEE Trans. Microw. Theory Tech.*, vol. MTT-16, no. 6, pp. 361-364, Jun. 1968.
- [4] C. H. Ho, L. Fan, and K. Chang, "New uniplanar coplanar waveguide hybrid-ring couplers and magic-T's", *IEEE Trans. Microw. Theory Tech.*, vol. 42, no. 12, pp. 2440-2448, Dec. 1994.
- [5] C. H. Ho, L. Fan, and K. Chang, "Broad-band uniplanar hybrid-ring and branch-line couplers," *IEEE Trans. Microw. Theory Tech.*, vol. 41, no. 12, pp. 2116-2125, Dec. 1993.
- [6] T. T. Mo, Q. Xue, and C. H. Chan, "A broadband compact microstrip rat-race hybrid using a novel CPW inverter," *IEEE Trans. Microw. Theory Tech.*, vol. 55, no. 1, pp. 161-167, Jan. 2007.
- [7] M. Aikawa and H. Ogawa, "A new MIC magic-T using coupled slot lines," *IEEE Trans. Microw. Theory Tech.*, vol. MTT-28, no. 12, pp. 523-528, Jun. 1980.
- [8] J. P. Kim and W. S. Park, "Novel configurations of planar multilayer magic-T using microstrip-slotline transitions," *IEEE Trans. Microw. Theory Tech.*, vol. 50, no. 7, pp. 1683-1688, Jul. 2002.
- [9] K. U-Yen, E. J. Wollack, J. Papapolymerou, and J. Laskar, "A broadband planar magic-T using microstripslotline transitions," *IEEE Trans. Microw. Theory Tech.*, vol. 56, no. 1, pp. 172-177, Jan. 2008.
- [10] U. Bulus, O. Kizilbey, H. Aniktar and A. Gunes, "Broadband Direction Finding Antenna using Suspended Microstrip Line Hybrid Coupler for Handheld Devices," *IEEE Antennas and Wireless Propagation Letters*, vol. pp, no. 99, Jan. 2013.