

# Speed Control of Induction Motor Based on Model Reference Adaptive Control

Hakan Acikgoz<sup>1</sup>, Ceyhun Yildiz<sup>2</sup>, Gulsade Kale<sup>3</sup>, O.Fatih Kececioglu<sup>2</sup>, Ahmet Gani<sup>2</sup>, Mustafa Sekkeli<sup>2</sup>

<sup>1</sup>Department of Electrical Science, Kilis 7 Aralik University, Turkey  
hakanacikgoz@kilis.edu.tr

<sup>2</sup>Department of Electrical and Electronics Engineering, Kahramanmaras Sutcu Imam University, Turkey  
cyildiz@yegm.gov.tr, fkececioglu@ksu.edu.tr, agani@ksu.edu.tr, msekkeli@ksu.edu.tr

<sup>3</sup>Department of Computer Science, Kilis 7 Aralik University, Turkey  
gkale@kilis.edu.tr

## Abstract

In recent years, adaptive and intelligent control schemes have begun to take the place of conventional control methods. In this study, a model reference adaptive control (MRAC) scheme based on genetic algorithm (GA) and Fuzzy Logic (FL) has been used by the help of Vector Control type driving method based on Space Vector Pulse Width Modulation (SVPWM). In this control technique, the conventional PI controller and the proposed control strategy has been applied to induction motor in real conditions by using an appropriate digital signal processor and peripheral units. As digital processor, DSPIC 30F6010 which is produced by Microchip Co. has been used. Experimental studies have been implemented for both of the control techniques under the same conditions. The results obtained from conventional PI controller and the proposed control strategy have been analysed and compared.

## 1. Introduction

Induction motors have many applications in the industry. Because they are simple, cheap, robust, reliable, durable and they need little maintenance. However, induction motors have some disadvantages such as mainly controllability due to its complex mathematical model and its nonlinear behavior [1-4]. In recent years, by the rapid development of microprocessor and power semiconductor technology, controlling methods of induction motors have been improved. In order to achieve high performance and better controllability, the field oriented control (FOC) has been investigated. DC motors have high performance in terms of dynamic behavior and their control is simple.

Armature and excited winding currents of self-excited DC motors can be independently controlled because they are vertical to each other. This is not the case in induction motors. In the FOC, induction motor can be controlled as a separately excited DC motor [1-6]. Since FOC was introduced in 1971 [6], a great number of articles have appeared in the literature to improve the high performance. These methods are fuzzy logic controller (FLC) and various adaptive controllers such as MRAC, sliding-mode controller, variable-structure controller, etc [7-9].

Before control studies, genetic algorithms, which are the stochastic search methods based on the natural process of evolution, were carried out and implemented in Matlab environment. Afterwards, the fuzzy logic based adaptive control

mechanisms have been developed. Classical fuzzy logic controller design is based on the trial-error methods and the expert information. Therefore, this method takes a longer time and the design is not always feasible to reach best outcomes. This method can be applied to the simple fuzzy logic controllers, but it is not convenient to complex parameters. In this case, different methods are used for the fuzzy logic controller design [10-14]. In recent years, GA has been used to design the fuzzy logic controllers. Thus, the ability of finding the best solutions is combined with effectively process structure of the fuzzy logic controllers [10-12].

Here, an adaptive control system is preferred in order to realize the speed control. By using fuzzy logic controller based on the model structure, a speed control system is established. The adaptive control system is an effective solution to solve speed control for vector controlled induction machine. Required control performance is represented with a reference model in the control system. Design of FLC based on the comparison of actual system output and reference model is quite difficult. GA is preferred to solve this problem. The best solutions are obtained in Matlab by characterizing the problem.

This paper deals with MRAC based on GA and fuzzy logic controller (GA+FMRAC) in speed control of vector controlled induction motor. An inverter-controlled induction motor is realized in the laboratory. Then, the comparison of the drive response under conventional PI and proposed control technique has been demonstrated by several graphics on a number of different reference speeds. After that, the performance of proposed control technique has been researched and compared with conventional PI controller.

## 2. Vector Control and Mathematical Model

Vector controlled induction motors are based on control principle of DC motors. DC motors have high performance in terms of dynamic behaviour and their control is simple. Armature and excited winding currents of self-excited DC motors can be independently controlled because they are vertical to each other. There isn't such case in induction motors [1-3]. Made studies on induction motors showed that these motors could be controlled such as DC motors if three-phase variables are converted to dq-axis and dq-axis components are controlled. Vector control methods which are done transform of axis have been developed. Thus, flux and torque of induction motors can be independently controlled [15-17]. The d-q equations of 3-

phase induction motor expressed in the stationary reference frame are:

$$V_{ds} = R_s i_{ds} + p \psi_{ds} \quad (1)$$

$$V_{qs} = R_s i_{qs} + p \psi_{qs} \quad (2)$$

$$0 = R_r i_{dr} + p \psi_{dr} - w_r \psi_{qr} \quad (3)$$

$$0 = R_r i_{qr} + p \psi_{qr} - w_r \psi_{dr} \quad (4)$$

The flux linkage equations:

$$\psi_{qs} = L_s i_{qs} + L_m i_{qr} \quad (5)$$

$$\psi_{ds} = L_s i_{ds} + L_m i_{dr} \quad (6)$$

$$\psi_{qr} = L_r i_{qr} + L_m i_{qs} \quad (7)$$

$$\psi_{dr} = L_r i_{dr} + L_m i_{ds} \quad (8)$$

Electromagnetic torque in the stationary reference frame is given as:

$$T_e = \frac{3}{2} \frac{P}{2} \frac{L_m}{L_r} (\psi_{ds} i_{qs} - \psi_{qs} i_{ds}) \quad (9)$$

Where;  $p = (d/dt)$ ,  $R_s$ ,  $R_r$  are stator and rotor resistances;  $L_s$ ,  $L_r$ ,  $L_m$  are stator, rotor and mutual inductances;  $\psi_{ds}$ ,  $\psi_{qs}$  are stator flux in d-q frame;  $\psi_{dr}$ ,  $\psi_{qr}$  are rotor flux in d-q frame;  $i_{ds}$ ,  $i_{qs}$ ,  $i_{dr}$ ,  $i_{qr}$  are stator and rotor currents in d-q frame,  $w_r$  is rotor speed and  $P$  is the pairs of poles.

SVPWM has been a very popular technique used in AC motor control. SVPWM goals to generate a voltage vector that is close to the reference circle through the various switching modes of inverter. Figure 1 demonstrates the schematic of a two-level inverter. As it seen figure 1, When switch of one leg is closed,  $S_i$  is 1 and when switch is opened,  $S_i$  is 0. In two level inverters have eight different (23=8) switching states. There are six active voltage vectors (V1-V6) and two zero voltage vectors (V0-V7). A typical space vector diagram of two-level inverter has been shown in Fig. 1. [8-11].

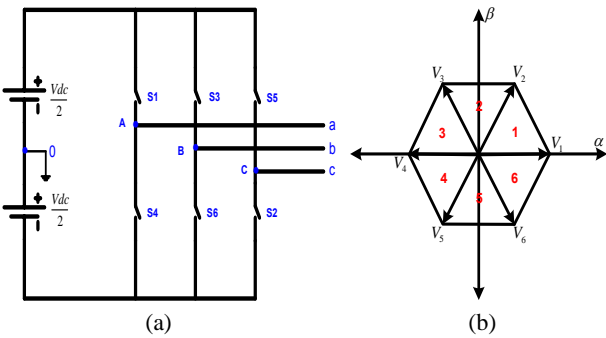

Fig. 1. a) Two-level inverter b) Space vector diagram of two-level inverter

### 3. Fuzzy logic and Genetic Algorithms

Fuzzy Logic Control is an appropriate method for designing nonlinear controllers via the use of heuristic information [18]. A FLC system allows changing the control laws in order to deal

with parameter variations and disturbances [19-23]. The block diagram of Fuzzy PD system for vector controlled induction motor is given in Fig. 2. The fuzzy PD controller has two inputs and one output. The inputs of FLC are speed error  $e(k)$  and change in speed error  $\Delta e(k)$ . These inputs are normalized to obtain error  $e(k)$  and its change  $\Delta e(k)$  in the range of -1 to +1. The fuzzy PD controller action can be written in the form of K-domain equations as follows:

$$u(t) = K_p e(t) + K_d \frac{de(t)}{dt} \quad (10)$$

$$u(k) = K_p e(k) + K_d \frac{(e(k) - e(k-1))}{T_s} \quad (11)$$

Where;  $K_p$  and  $K_i$  are gain factors,  $T_s$  is sample time.

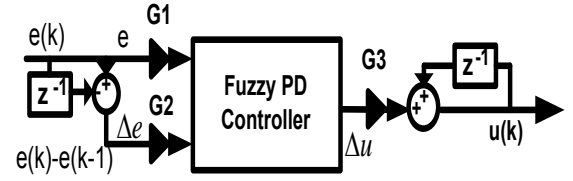

Fig. 2. Fuzzy PD controller system

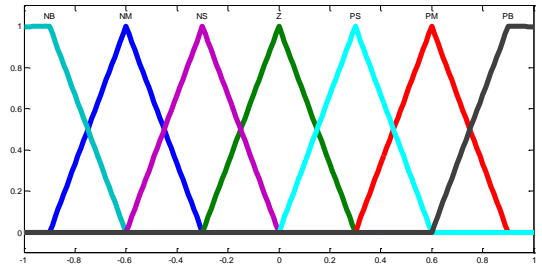

Fig. 3. Membership functions for inputs and output

Table 1. Rule Base

de / e	NB	NM	NS	Z	PS	PM	PB
NB	NB	NB	NB	NB	NM	NS	Z
NM	NB	NB	NM	NM	NS	Z	PS
NS	NB	NM	NS	NS	Z	PS	PM
Z	NB	NM	NS	Z	PS	PM	PB
PS	NM	NS	Z	PS	PS	PM	PB
PM	NS	Z	PS	PM	PM	PB	PB
PB	Z	PS	PM	PB	PB	PB	PB

The fuzzy membership functions consist of seven fuzzy sets: NB, NM, NS, Z, PS, PM, PB as shown in fig. 3. The rule base of FLC system is given in Table 1. There may be  $7 \times 7 = 49$  possible rules in the matrix. GAs are a stochastic global search method that mimics the process of natural evolution. It is one of the methods used for optimization. GAs are reliable and robust methods for searching solution spaces. GAs were introduced by John Holland in 1970. GAs have three main stages such as reproduction, crossover and mutation. GAs starts with no

knowledge of the correct solution and depends wholly on responses from its environment and evolution operators such as reproduction, crossover and mutation to succeed at the best solution. By starting at several independent points and searching in parallel, the algorithm avoids local minimum and converging to sub optimal solutions [11-14]. Genetic algorithm process flowchart is shown in fig.4.

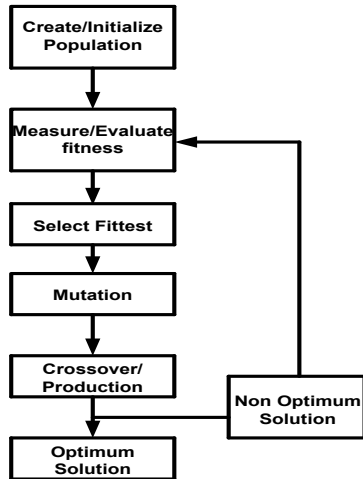

Fig. 4. Genetic algorithm process flowchart

#### 4. Fuzzy Adaptive Control

Adaptive control takes an important part in modern control systems. While control system is running, it works against to various disturbances, parameter variations and changes in the operating conditions. The success of the first adaptive control has appeared with the realization of a time-varying mass control of the rocket and spacecraft. One of the direct adaptive control methods is MRAC.

This mechanism has been proposed to be performed in aircraft control. The adaptation of these control systems is performed by comparing the system output and reference based model output. Thus, an error signal ( $e_m$ ) is obtained. The signal from the output of the adaptation mechanism is used for the parameter or signal adaptation. The block diagram of a MRAC system is given in fig. 55.

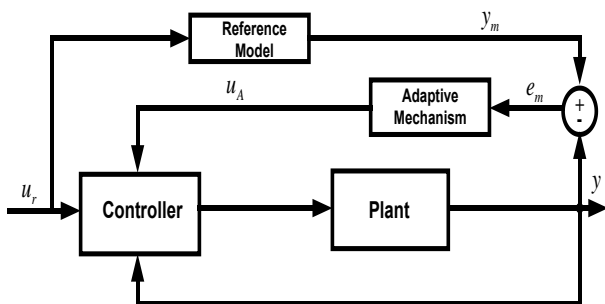

Fig. 5. MRAC system

A fuzzy adaptive control system is designed in Fig. 6, which is used as a suitable structure such as PD-type FLC with feedback mechanism. The inputs of the adaptation mechanism are the difference between the reference model and system outputs (error), and variation for a sampling time of this

difference (error variation). The output is used to adjust the gain of the fuzzy logic. Fuzzy model reference adaptive control (FMRAC) system has six gains, which are occurred with two gains in the fuzzy logic and adaptation mechanism, and one gain in the outputs. The gain of the FLC output is adjusted by using adaptation mechanism and this setting affects directly the signal of the control system. The other five gains are parameters that affect the performance of the control system [24-27]. The algorithm aims to determine the gains affecting the desired system performance. Each individual of the GA consists of combination of the five gains. Each member of the community is decomposed to achieve the necessary gain values. Each individuals' performance is determined by evaluating the degree of compatibility. It impacts the probability of survival of individuals and provides the desired values passed to new generations [10,11,26].

Design of a MRAC scheme based on GA is especially complex due to have more parameters affecting the control system performance. Therefore, GA is used to solve this complex problem. As it seen in Fig. 6, G1, G2, G3, G4, G5, G6 gains are selected as parameters and created society of individuals, which represent all of these parameters. Thus, the problem is optimized to be solved by GA.

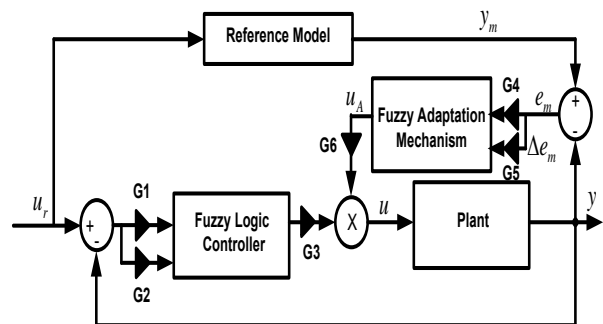

Fig. 6. The Proposed Control Technique

The conformity assessment function is established by sum of the absolute value which obtained from the error of the reference speed and actual speed. By using Matlab/Genetic Algorithm, the conclusions are given as shown in fig. 7.

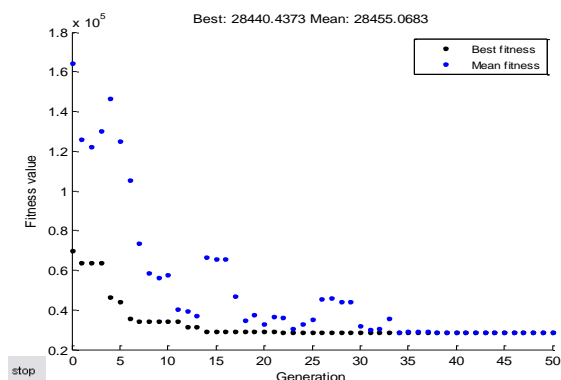

Fig. 7. Optimized result of GAs

#### 5. Simulation and Experimental Results

In this section, in order to validate the performance of the proposed control technique, an experimental setup was designed

as it was shown in fig.8. The experimental setup consists of an induction motor, encoder, dsPIC 30f6010, measurement and IGBT card. The proposed control technique for vector controlled induction motor is experimentally implemented using digital signal processor board dsPIC 30f6010 through both hardware and software. The parameters of the induction motor are given in Table 2.

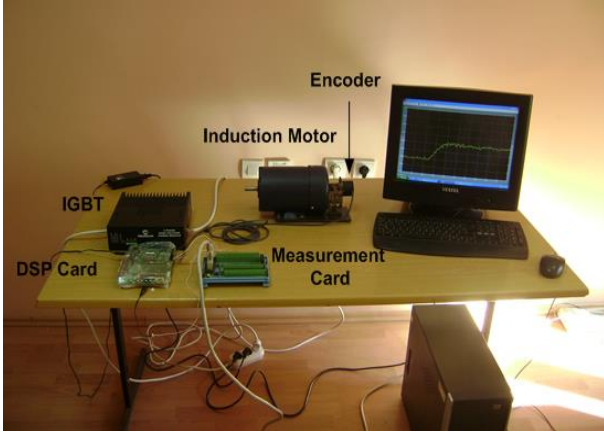

Fig. 8. The Proposed Control Technique

Table 2. Rule Base

Parameters	Values
Stator resistance ( $R_s$ )	1.45 $\Omega$
Rotor resistance ( $R_r$ )	1.93 $\Omega$
Number of poles (P)	2
Stator self-inductance ( $L_s$ )	0.4H
Rotor self-inductance ( $L_r$ )	0.599H
Moment of inertia (J)	0.03kg-m <sup>2</sup>
Mutual inductance ( $L_m$ )	0.18787H
Friction factor (B)	0.03

The simulation results of PI controller and proposed control technique are shown in Fig.9-13. It represents the speed performance, torque response and stator currents at no-load for vector controlled induction motor drive. Figure 9 and 12 show the speed performance of the vector controlled induction motor drive using PI controller and proposed control technique. According to the simulation results, The proposed controller has a remarkably better response than the PI speed controller.

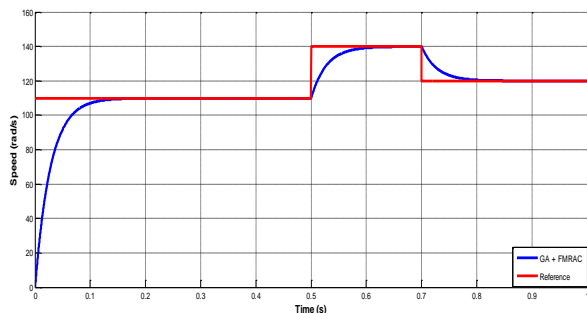

Fig. 9. Speed control performance of the proposed control technique

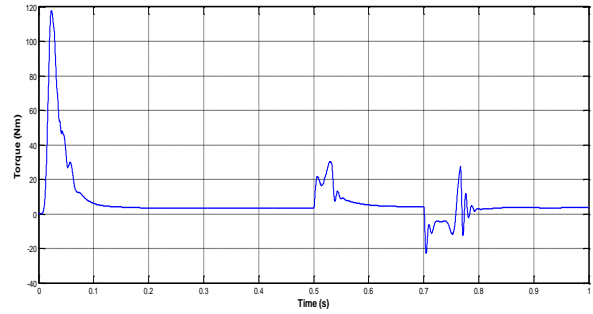

Fig. 10. Torque response of the proposed control technique

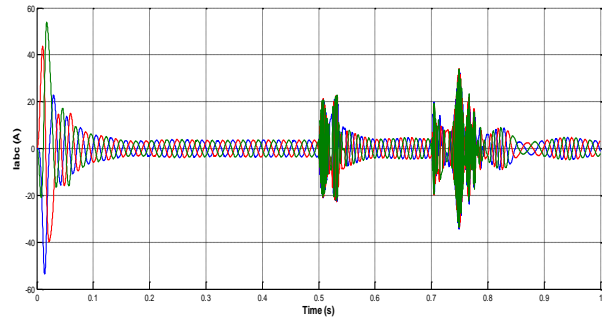

Fig. 11. Stator currents of the proposed control technique

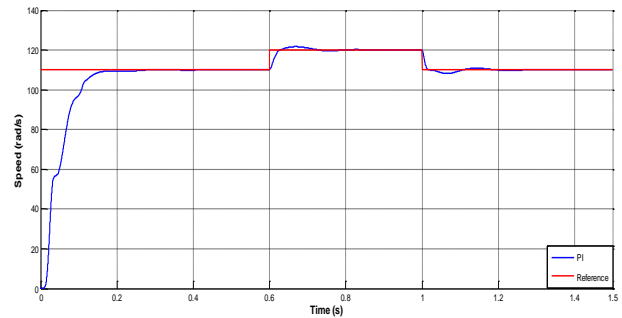

Fig. 12. Speed control performance of the PI controller

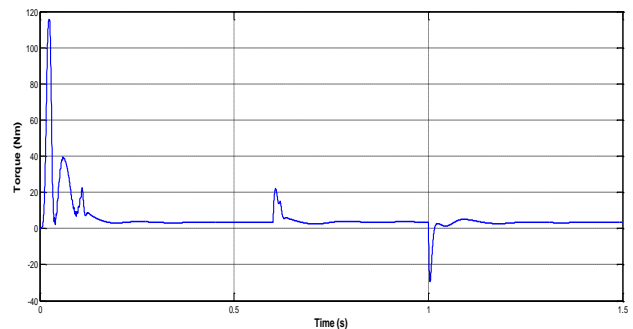

Fig. 13. Torque response of the PI controller

Several experimental results for speed control of vector controlled induction motor drive using PI controller and the proposed control technique are realized. The experimental results are performed for different reference speeds with no-load during 10 sec. Figure 14 shows the performance of conventional PI controller. In the figure 14, unloaded induction motor has been accelerated. Induction motor starts to operate at a steady state at 2000 rpm reference speed. Then, a sudden step speed

command increasing, from 2000 rpm to 3800 rpm is applied. Then, the reference speed is reduced from 3800 rpm to 1000 rpm at 6 seconds. As seen in Fig. 14, the PI controller response reaches the reference speed after nearly 4 sec. with overshoot.

Figure 15 demonstrates the dynamic response of the proposed control technique. As it seen in fig. 15, the reference speed is chosen 2000 rpm. At 2 seconds, the reference speed is increased to 3800 rpm. Then, the reference speed is changed from 3800 rpm to 1000 rpm at 6 seconds. As can be seen from figure 16, the proposed control technique response reaches to reference speed after nearly 2.5 seconds without overshoot.

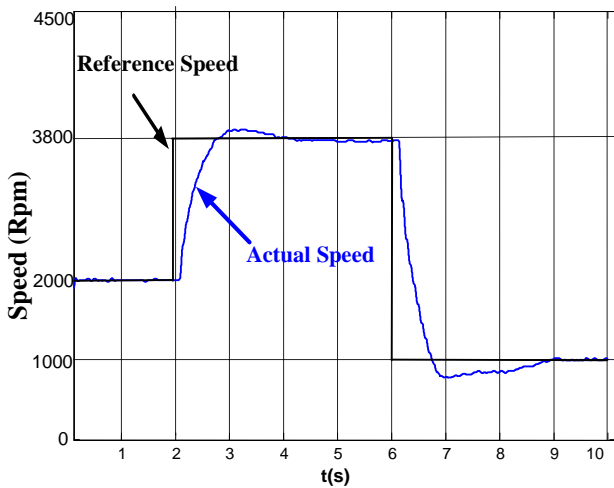

Fig. 14. Speed control performance of the proposed control technique

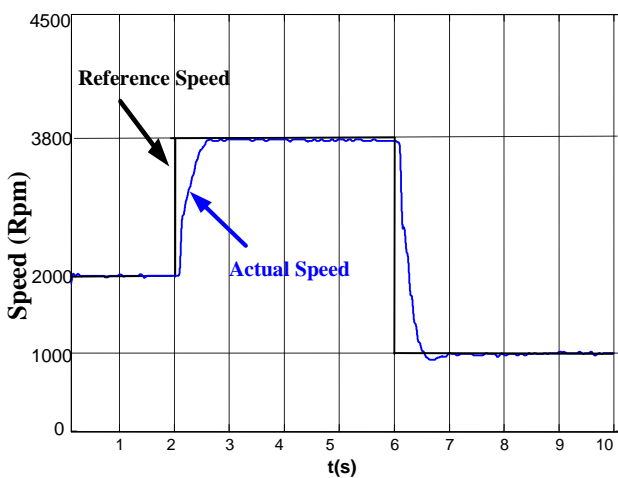

Fig. 15. Speed control performance of the PI controller

In Fig. 16, the reference speed is chosen as 2000 rpm. Unloaded induction motor is required to accelerate from 2000 rpm to 3800 rpm in 2 seconds. The reference speed is kept constant at 3800 rpm from time,  $t=2$  sec to 6 sec. After that, the reference speed is changed from 3800 rpm to 1000 rpm in 6 seconds. As it can be seen, the proposed control technique gives better performance against the conventional PI controller with respect to overshoot and response time.

In the Fig. 17, the reference speed is 1000 rpm. Then, a sudden step command increasing, from 1000 rpm to 3400 rpm is applied. After that, the reference speed is decreased from 3400 rpm to 2000 rpm. As can be seen from Fig. 17, the proposed

control technique follows the reference speed without overshoot and steady state error. While the conventional PI controller follows the reference speed with overshoot.

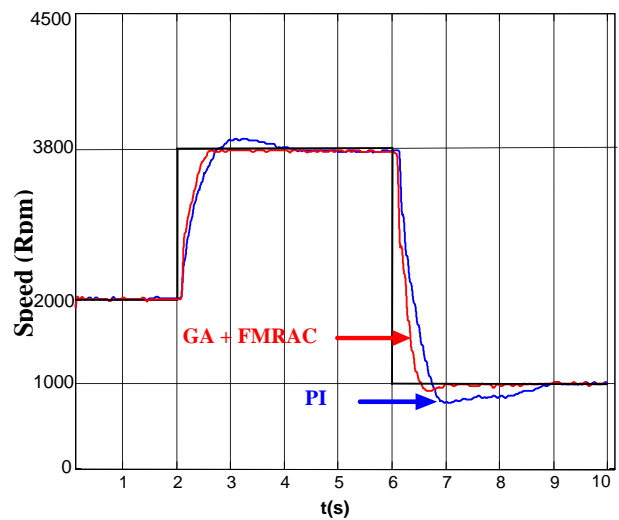

Fig. 16. Comparison of the speed responses of the controllers

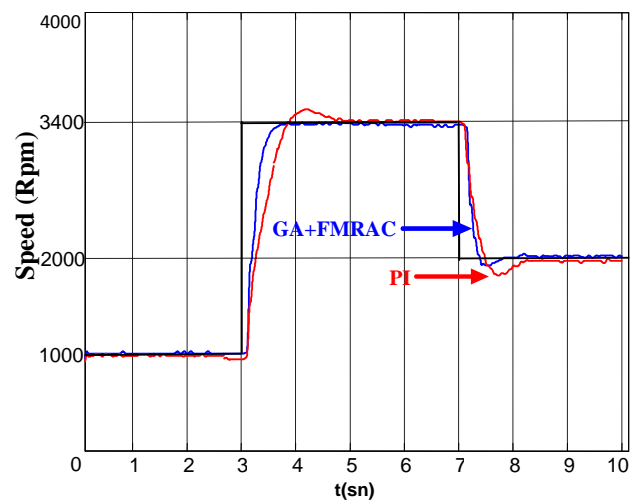

Fig. 17. Comparison of the speed responses of the controllers

## 6. Conclusions

In this work, a MRAC scheme based on genetic algorithm and fuzzy logic controller has been used for vector controlled induction motor. The motor drive system is performed using both conventional PI and the proposed control technique. Both of the control systems are compared and the effectiveness of the proposed control technique against PI control performance is illustrated. The running of the induction motor in real conditions has demonstrated that the reference speed values have been obtained with smooth convergence regime and rather small error values being left under the 2 per cent of set values in a good response time. As a conclusion, Considering the overshoot and the response time, the proposed control technique gives obviously better performance than the conventional PI controller.

## 7. References

- [1] P. C. Sen, "Electric Motor Drives and Control Past Present, and Future", IEEE Transactions on Industrial Electronics, Vol.37, No.6, 562-575, 1990.
- [2] B. K., Bose, "Modern Power Electronics and AC Drivers", Prentice Hall, New Jersey, 2002.
- [3] E.Y.Y. Ho and P.C. Sen, "Decoupling Control of Induction Motor Driver", IEEE Transactions on Industrial Electronics, Vol.35, No.2, 253-262, 1988.
- [4] J. A. Santisteban and, R. M. Stephan, "Vector Control Methods for Induction Machines: An Overview", IEEE Transactions on Education, Vol.44, No.2, 170-175, 2001.
- [5] D. W. Novotny and, R. D. Lorenz, "Introduction to Field Orientation and High Performance AC Drives", IEEE, Tutorial Course Notes, 1986.
- [6] F. Blaschke, "A New Method for the Structural Decoupling of AC Induction Machines", In Conf. Rec. IFAC, Dusseldorf, Germany, Oct. pp. 1-15, 1971.
- [7] B. Yoo and W. Ham, "Adaptive fuzzy sliding mode control of nonlinear system," IEEE Transactions on Fuzzy Systems, vol. 6, no. 2, pp. 315-321, 1998.
- [8] Y. Xia and Y. Jia, "Robust sliding-mode control for uncertain time-delay systems: an LMI approach," IEEE Transactions on Automatic Control, vol. 48, no. 6, pp. 1086-1092, 2003.
- [9] V. I. Utkin, "Sliding Modes and Their Application in Variable Structure Systems", MIR Publishers, Moscow, Russia, 1978.
- [10] C. Yildiz, "Vector Control of AC Induction Machine Using Genetic Algorithm Based Fuzzy Controller", MSc Thesis, Department of Electrical and Electronics Engineering, K.Maras Sütcü İmam University, K.Maras, Turkey, 2008.
- [11] R.A. Mansfield, "Genetic Algorithms", University of Wales College of Cardiff, 1990.
- [12] D. E. Goldberg, "Genetic Algorithms in Search, Optimization and Machine Learning" Addison-Wesley Pub. Co., 1989.
- [13] S. Gotshall and B. Rylander, "Optimal Population Size And The Genetic Algorithm.", Proc On Genetic And Evolutionary Computation Conference, 2000.
- [14] D.E. Goldberg, "Genetic Algorithms in Search, Optimisation and Machine Learning", Addison Wesley, 1989.
- [15] B. K., Bose, "High Performance Control and Estimation in AC Drives", IECON 97, 23rd International Conference on Industrial Electronics, Control and Instrumentation, Vol.2, 377-385, 1997.
- [16] L. Harnefors, "Design and Analysis of General Rotor Flux Oriented Vector Control Systems", IEEE Transactions on Industrial Electronics, Vol.48, No.2, 2001.
- [17] A. M. Trzynadlowski, "Control of Induction Motors", Academic Press, San Diego, USA, 2001.
- [18] L. A. Zadeh, "Fuzzy Sets. Informat and Control", Vol. 8: 338-353, 1965.
- [19] C. T. Lin and C. S. Lee, "Neural Fuzzy Systems", Prentice Hall PTR, New Jersey, 1996.
- [20] T. J. Ross, "Fuzzy Logic with Engineering Applications", McGraw-Hill Inc., ISBN 0-07-053917-0, 1995.
- [21] R. Babuska, "Fuzzy Modeling for Control", Kluwer Academic Publishers, Boston, 1998.
- [22] D. Dubois, J. Lang, and H. Prade, "Fuzzy Sets in approximate Reasoning, Part II: Logical Approaches", Fuzzy Sets and Syst., Vol.40, No.1, 203-244, 1991.
- [23] M. Sekkeli, C. Yildiz, H.R. Ozcalik, "Fuzzy Logic Based Intelligent Speed Control of Induction Motor Using Experimental Approach" International Symposium on Intelligent Systems and Applications, Trabzon/Turkey, June 29-July 1, 2009.
- [24] C. S. Draper, Y.T. Li, "Principles of Optimizing Control Systems and an Application to the Internal Combustion Engine", ASME Publications, New York, 1951.
- [25] O. Gizolme, F. Thollon, "Shape Optimization of Synchronous Machine Rotor", International Journal of Applied Electromagnetics and Machines, Vol 9, Issue 3, 1998.
- [26] H.P. Whitaker, J. Yamron, A. Kezer, "Design of Model Reference Adaptive System for Aircraft", R-164, Instrumentation Laboratory, MIT, Cambridge USA, 1958.
- [27] S. Maiti, "Model Reference Adaptive Controller Based Rotor Resistance and Speed Estimation Techniques for Vector Induction Motor Drive Utilizing Reactive Power", IEEE Trans. on Industry Electronics, vol. 55, pp. 594-601, Feb. 2008.