

Robust & Optimal Model Predictive Controller design for Twin Rotor MIMO System

Abasin Ulasyar*, Haris Sheh Zad

Department of Electrical & Electronics Engineering, KOC University Istanbul, Turkey

*Corresponding author: E-mail address: aulasyar14@ku.edu.tr

Abstract

In this paper a two degree of freedom Twin Rotor MIMO System (TRMS), which is employed to model the pitch and yaw directions of a helicopter, is considered. Using the model of TRMS, MATLAB simulations are performed. The open loop model of the system is unstable. Since the system is both controllable and observable, a robust and optimal Model Predictive Controller (MPC) is designed to control the system. The simulations of the controller give better results as compared to the one obtained from LQR approach.

1. Introduction

The aim for designing a controller for the twin rotor mimo system is that it provides an experimental platform in order to control the flight of helicopter [1]. The modeling of TRMS and the development of different type of robust controllers have achieved lot of attention because of the fact that the dynamics of TRMS are similar to that of helicopter in many aspects [2-4]. The control problem of TRMS is considered challenging because of the fact that the dynamics of TRMS are nonlinear and unstable and also there is high coupling effect present between the two propellers [5]. Twin Rotor MIMO System can therefore be considered as complex and unconventional air vehicle that contains tough challenges in its modelling, design of controller and its implementation [6]. The TRMS is capable of doing rotation in both the directions i.e. horizontal and vertical. A lift force is generated by the main rotor which makes the TRMS capable of moving around the pitch axis in the upward direction. The movement around the yaw axis is done with the tail rotor [1].

Several modeling and control techniques have been implemented for TRMS. The detail description about the modeling of dynamic Twin Rotor MIMO System has been provided in [7]. An optimal controller has been proposed using the model decoupled method in [8]. The authors have used two independent SISO systems in order to model the TRMS. A time optimal controller is developed for TRMS in [9]. Genetic algorithm based PID controller is designed for TRMS in [10]. A comparison between intelligent control and classical control for TRMS has been given in [11]. In order to track the pitch and yaw angles, adaptive controllers have been designed in [12-14]. [15] and [16] have proposed controller for TRMS based on feedback linearization, in which the assumption is made that all the states are measurable, which is not feasible practically. As all of the states of a laboratory model of the TRMS are not available for measurement so an observer based state feedback controller is necessary in order to estimate the unmeasurable states as proposed in [17, 18]. The design of observer can not be

made independently from the state feedback because of the nonlinearity present in the model. For designing a linear controller, when taken into account the model uncertainties, the design of observer cannot be carried out separately from state feedback control [19]. A sliding mode state observer controller has been developed for TRMS in [20]. The conditions for asymptotic stability have been derived using the Lyapunov method for the robust sliding mode control. Using the black box identification technique, a dynamic model has been proposed for a single degree of freedom TRMS in [10]. An LQG regulator is connected to this extracted model. The authors have shown how the performance of the system has been increased with the use of artificial non-aerodynamic forces. In [9] an optimal controller has been presented for TRMS, where the system has been decoupled into independent SISO systems for the motions in horizontal and vertical directions and distinct controllers have been developed for the two systems. The coupling effects have been considered as disturbances to the system.

Model Predictive Control is a specific branch of model based design. MPC is widely used in the industry for designing controllers for highly complex MIMO processes [21]. The main theme behind MPC is to start from the *model* of the open loop plant which gives the dynamical relationships between the system variables i.e. command inputs, measured states and internal states [22]. Then different constraints are added on the system variables e.g. input limitations, and required ranges of the states and outputs. The control problem is completed with the desired performance specifications which are expressed by different actuator efforts and weights on the tracking errors. With the addition of constraints to the linear quadratic optimal control problems with infinite horizon makes it very difficult to find an explicit solution. Such difficulties are overcome by using the Model Predictive Control, which defines an open loop control problem, and then solves it online iteratively. MPC uses the system current state as the initial condition and gives a closed loop feedback optimal controller.

In this paper, a linear dynamic model for twin rotor MIMO system has been developed in section 2. In section 3, the design of Model Predictive Control technique has been explained. Section 4 describes the results obtained by applying the MPC control strategy to the TRMS system and its comparison with the LQR based controller scheme. The last section consists of conclusion.

2. Mathematical modeling of TRMS

The mathematical model of TRMS is nonlinear as at least one of the states i.e. position of the rotor or current is the argument of a nonlinear function. In order to design a controller for the flight of TRMS, the non linear model should be linearized.

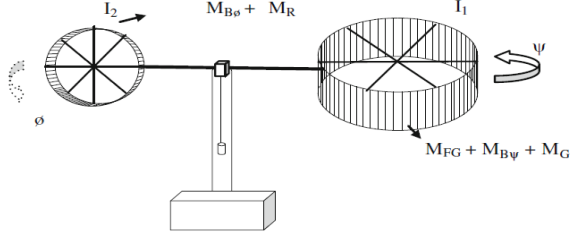

Figure 1: Twin Rotor MIMO System

The nonlinear equations of TRMS are derived from Figure 1 and the parameters are shown in table 1 [23, 24]. In vertical plane the pitch has equation of motion as given in Eq. (1).

$$I_1 \cdot \ddot{\Psi} = M_1 - M_{FG} - M_{B\psi} - M_G \quad (1)$$

The rotor has nonlinearity which is given by M_1 . Torque is induced due to this nonlinearity which is given as below.

$$M_1 = a_1 \cdot T_1^2 + b_1 \cdot T_1 \quad (2)$$

The gravitational torque is generated about the pivot point due to the weight of the helicopter, which is given in Eq. (3).

$$M_{FG} = M_g \cdot \sin \Psi \quad (3)$$

The frictional torque is modeled as viscous and coulomb frictions and is given in Eq. (4).

$$M_{B\psi} = B_{1\psi} \cdot \dot{\Psi} + B_{2\psi} \cdot \text{sign}(\dot{\Psi}) \quad (4)$$

The gyroscopic torque is given by Eq. (5). It is generated when main rotor changes its position in the direction of azimuth.

$$M_G = K_{gy} \cdot M_1 \cdot \dot{\phi} \cdot \cos \Psi \quad (5)$$

For modeling motor and electrical control circuitry, the first order transfer function is used. In Laplace domain the motor momentum is given by Eq. (6).

$$T_1 = K_1 \cdot u_1 / (T_{11} s + T_{10}) \quad (6)$$

In horizontal plane of motion, similar equations are developed for Yaw which are given by Eq. (7), Eq. (8), Eq. (9) & Eq. (11).

$$I_2 \cdot \ddot{\phi} = M_2 - M_{B\phi} - M_R \quad (7)$$

$$M_2 = a_2 \cdot T_2^2 + b_2 \cdot T_2 \quad (8)$$

$$M_{B\psi} = B_{1\phi} \cdot \dot{\Psi} + B_{2\phi} \cdot \text{sign}(\dot{\phi}) \quad (9)$$

First order transfer function is used to approximate the cross reaction momentum M_R and is given by Eq. (10).

$$M_R = K_c \cdot (T_0 s + 1) \cdot \frac{T_1}{T_p s + 1} \quad (10)$$

$$T_2 = K_2 \cdot u_2 / (T_{21} s + T_{20}) \quad (11)$$

The mathematical model which is given in Eq. (1) to Eq. (11) is linearized about, $X_0 = [0 \ 0 \ 0 \ 0 \ 0 \ 0 \ 0]$

There are seven states and two outputs for two inputs. The output and states vectors are given by $X = [\Psi \ \phi \ T_1 \ T_2 \ M_R \ \dot{\Psi} \ \dot{\phi}]^T$ and $Y = [\Psi \ \phi]^T$

The general state space representation of TRMS is represented as below.

$$\dot{X} = AX + BU \quad (12)$$

$$Y = CX + DU \quad (13)$$

After linearization and using the parameters given in Table (1), the system matrices are given below.

$$A = \begin{pmatrix} 0 & 0 & 0 & 0 & 0 & 1 & 0 \\ 0 & 0 & 0 & 0 & 0 & 0 & 1 \\ 0 & 0 & -0.909 & 0 & 0 & 0 & 0 \\ 0 & 0 & 0 & -1 & 0 & 0 & 0 \\ 0 & 0 & 0.218181 & 0 & -0.5 & 0 & 0 \\ -4.70588 & 0 & 1.358823 & 0 & 0 & -0.088235 & 0 \\ 0 & 0 & 0 & 4.5 & -50 & -5 & 0 \end{pmatrix}$$

$$B = \begin{pmatrix} 0 & 0 \\ 0 & 0 \\ 1 & 0 \\ 0 & 0.8 \\ -0.35 & 0 \\ 0 & 0 \\ 0 & 0 \end{pmatrix} \quad C = \begin{pmatrix} 1 & 0 & 0 & 0 & 0 & 0 & 0 \\ 0 & 1 & 0 & 0 & 0 & 0 & 0 \end{pmatrix}$$

Table 1: Physical parameters of TRMS

Symbol	Parameter	Value
I_1	Vertical rotor moment of inertia	$6.8 * 10^{-2} \text{kgm}^2$
I_2	Horizontal rotor moment of inertia	$2 * 10^{-2} \text{kgm}^2$
a_1	Parameter of static characteristic	0.0135
a_2	Parameter of static characteristic	0.0924
b_1	Parameter of static characteristic	0.02
b_2	Parameter of static characteristic	0.09
M_g	Gravity momentum	0.32 N-m
$B_{1\psi}$	Parameter of friction momentum	$6 * 10^{-3} \text{Nms/rad}$
$B_{2\psi}$	Parameter of friction momentum	$1 * 10^{-3} \text{Nms}^2/\text{rad}$
$B_{1\phi}$	Parameter of friction momentum	$1 * 10^{-1} \text{Nms/rad}$
$B_{2\phi}$	Parameter of friction momentum	$1 * 10^{-2} \text{Nms}^2/\text{rad}$
K_{gy}	Parameter of gyroscopic momentum	0.05 s/rad
k_1	Motor 1 gain	1.1
k_2	Motor 2 gain	0.8
T_{11}	Motor 1 denominator	1.1
T_{10}	Motor 1 denominator	1
T_{21}	Motor 2 denominator	1
T_{20}	Motor 2 denominator	1
T_p	Cross reaction momentum parameter	2
T_0	Cross reaction momentum parameter	3.5
k_c	Cross reaction momentum gain	-0.2

3. Model Predictive Controller design

Model Predictive Control (MPC) is a strategy applied for optimally controlling multivariable problems of complex systems. It is easy to tune and handle unstable systems in the presence of input and output constraints. By using appropriate

model of a system optimized at regular intervals, its control inputs and system outputs can be easily predicted. MPC contains the implementation of prediction, optimization and receding horizon.

Block diagram of Model Predictive Control scheme is as shown below in Figure 2.

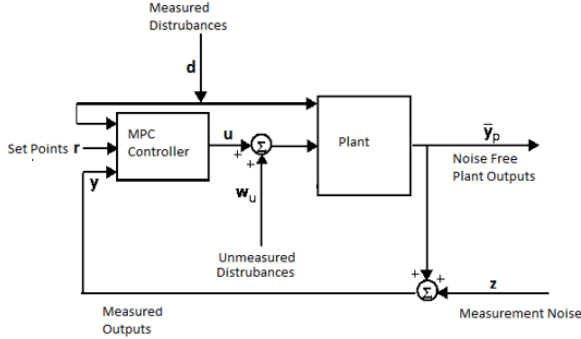

Figure 2: Model Predictive Controller scheme

In the above figure, manipulated variable ‘u’, measured disturbance ‘d’ (modeled as step input) and unmeasured disturbance ‘w_u’ (modeled as Gaussian noise) are going into the plant model. The measured disturbance ‘d’ also goes to MPC controller block, so that the controller parameters are tuned according to it. \bar{y}_p is the output of plant without any noise. During the measurements at the output, ‘z’ (modeled as white noise) corrupts the signal. The corrupted signal is fed back to the MPC controller where it is estimated and tracked with set point ‘r’ to remove any steady state error.

The MPC algorithm is based on the linear discrete time model of the open loop plant as given below.

$$x(t+1) = Ax(t) + Bu(t) \quad (14)$$

Where $x(t) \in R^n$ is the vector containing states at time t, and $u(t) \in R^m$ is the vector which contains manipulated variables that will be determined by the controller, and on solving the finite time control problem optimally given below.

$$\min_u \hat{x}_N^T P x_N + \sum_{k=0}^{N-1} [\hat{x}_k^T Q x_k + \hat{u}_k^T R u_k] \quad (15a)$$

$$\text{Such that } x_{k+1} = Ax_k + Bu_k, k = 0, \dots, N-1 \quad (15b)$$

$$x_0 = x(t) \quad (15c)$$

$$u_{\min} \leq u_k \leq u_{\max}, k = 0, 1, \dots, N-1 \quad (15d)$$

$$y_{\min} \leq Cx_k \leq y_{\max}, k = 0, 1, \dots, N-1 \quad (15e)$$

N is called prediction horizon. The manipulated variables are given by the sequence $U \triangleq [\hat{u}_0 \dots \hat{u}_{N-1}] \in R^{Nm}$ and this sequence has to be optimized, $Q = \hat{Q} \geq 0, P = \hat{P} \geq 0$ and $R = \hat{R} > 0$ are the weight matrices which define the performance index, $u_{\min}, u_{\max} \in R^m, y_{\min}, y_{\max} \in R^p, C \in R^{p \times n}$ are the constraints on the input and state variables. Component-wise inequality is denoted by \leq . The Quadratic Programming (QP) problem is obtained when $x_k = A^k x(t) + \sum_{j=0}^{k-1} A^j B u_{k-1-j}$ is substituted in Eq. (15), and is given as below,

$$U^*(x(t)) \triangleq \arg \min_u \frac{1}{2} \hat{U} H U + \hat{x}(t)^T \hat{C} U + \frac{1}{2} \hat{x}(t)^T Y x(t) \quad (16a)$$

$$\text{Such that } G U \leq W + S x(t) \quad (16b)$$

Where $U^*(x(t)) = [\hat{u}_0^*(x(t)) \dots \hat{u}_{N-1}^*(x(t))]'$ denotes the optimal solution. The following iterations are executed in MPC

control problem: at time t, the current state $x(t)$ is measured or estimated, then in order to obtain the optimal sequence of $U^*(x(t))$, QP problem is solved and then $u(t) = u_0^*(x(t))$ is applied to the process, the remaining optimal moves are discarded and the procedure is repeated at the next time interval $t+1$. For a reference signal $r(t) \in R^p$ tracking by the output vector $y(t) = Cx(t) \in R^p$ under the given constraints, the cost function given in Eq. (15a) is replaced as below.

$$\sum_{k=0}^{N-1} (y_k - r(t)) Q_y (y_k - r(t)) + \Delta \hat{u}_k^T R \Delta \hat{u}_k \quad (17)$$

Where the output matrix weights are $Q_y = \hat{Q}_y \geq 0 \in R^{p \times p}$ and the new variables for optimization are $\Delta u(t) \triangleq u(t) - u(t-1)$ which are further constrained possibly by $\Delta u_{\min} \leq \Delta u_k \leq \Delta u_{\max}$. Many different horizons can be used in Eq. (15) instead of using a single horizon N for limiting the complexity of the QP problem. In Eq. (15a) an output horizon N_y can be used, an input horizon given by $N_u \leq N_y$ with $u_k = 0$ for $k \geq N_u$ can be used in Eq. (15d) and a constraint horizon can be used in Eq. (15e) given by $N_{cy} \leq N_y$.

For some state values $x(t)$, MPC is terminated. In that case the output constraints are often considered as soft constraints as explained by equation given below.

$$y_{\min} - \epsilon V_{\min} \leq Cx_k \leq y_{\max} + \epsilon V_{\max} \quad (18)$$

Where $\epsilon \geq 0$ is used for violation of constraints. V_{\max} & V_{\min} are vectors of R^p with values as non-negative. The greater the value in the vector, the softer would be that constraint.

In order to reject the measured disturbances $v(t) \in R^{n_v}$ going into the system as $x(t+1) = Ax(t) + Bu(t) + B_v v(t)$, $v(t)$ is considered as constant over the whole prediction horizon. Due to this, the equations (15b) & (15e) would become as given by Eq. (19).

$$\begin{aligned} x_{k+1} &= Ax_k + Bu_k + B_v v(t) \\ y_{\min} &\leq Cx_k + D_v v(t) \leq y_{\max} \end{aligned} \quad (19)$$

For designing a controller based on linear models having information of $v(t)$, the model would become

$$\begin{bmatrix} x_{k+1} \\ v_{k+1} \end{bmatrix} = \begin{bmatrix} A & B_v \\ 0 & I \end{bmatrix} \begin{bmatrix} x_k \\ v_k \end{bmatrix} + \begin{bmatrix} B \\ 0 \end{bmatrix} u_k \quad (20)$$

Moreover, for the unmeasured disturbances $d(t) \in R^{n_d}$ going into the system as,

$$\begin{aligned} x(t+1) &= Ax(t) + Bu(t) + B_d d(t) \\ y(t) &= Cx(t) + D_d d(t) \end{aligned} \quad (20)$$

The unmeasured disturbance state is affected by white noise with unit covariance and zero mean. Therefore, it is estimated using a linear observer (Kalman filter) from measurements of system model.

4. Results

In order to implement the mentioned MPC controller for TRMS, MATLAB/Simulink is used as a simulation tool. The performance of the MPC controller is shown in this section with the addition of disturbance to input and output of TRMS. Also the performance of MPC controller is compared with LQR controller for the TRMS reference input tracking. Figure 3 shows the output of TRMS in response to the reference inputs of 0.2 rad for Pitch and 0.5 rad for Yaw in the presence of measured input step disturbance. The constraints on both the

control inputs u_1 and u_2 in Eq. (6) and Eq. (11) respectively range from -2.5 to 2.5 volts. The constraints on outputs are from -3.4 to +3.4 radians for pitch and from -3.5 to +3.5 radians for yaw. The control interval is 0.1.

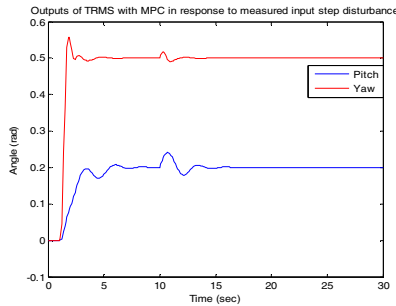

Figure 3: Output of TRMS with MPC in response to measured input disturbance

A measured step disturbance of 0.1 is introduced into the system at time $t=10$ seconds and the disturbance rejection response of the controller is shown accordingly in Figure 3. The settling time after the application of the input disturbance is 2.5 seconds.

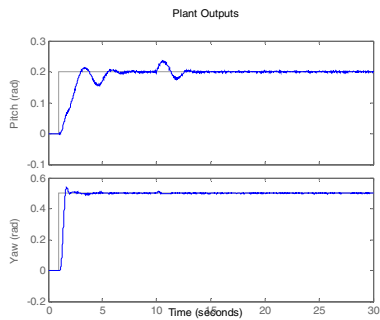

Figure 4: Output of TRMS with MPC to unmeasured Gaussian noise

Figure 4 shows the response of MPC to unmeasured Gaussian noise entering into the plant at $t=1$ seconds in addition to measured step input disturbance.

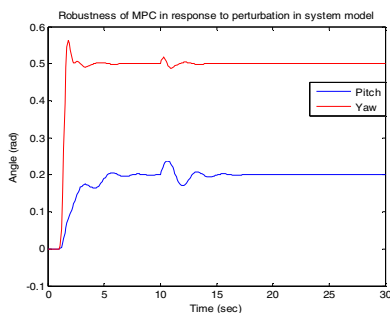

Figure 5: Output of TRMS with MPC in response to perturbation in the system dynamics

The effect of Gaussian noise is eliminated by the MPC controller. The dynamics of TRMS are perturbed by 10% in order to check the robustness of the designed MPC controller. Figure 5 shows the output response of the controller having good robustness against the perturbation in the system dynamics. Moreover the effect of measured input step

disturbance of magnitude 0.1 entered at $t=10$ seconds is also eliminated with addition to perturbation rejection. In order to see the effect of measurement noise of type White noise along with perturbation in the system dynamics, a White noise of magnitude 0.1 is added to the system. The resulting response of the MPC is shown in Figure 6 which shows that the controller rejects the white noise efficiently.

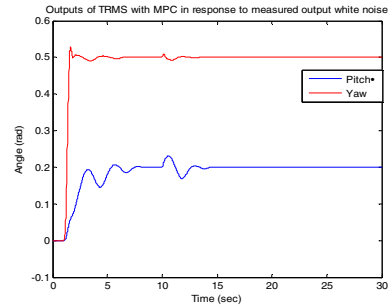

Figure 6: Output of TRMS with MPC in response to measurement noise

The results of MPC controller are compared with LQR controller for reference tracking of TRMS. Figure 7 shows the pitch angle output result in response to a reference input of 0.2 rad.

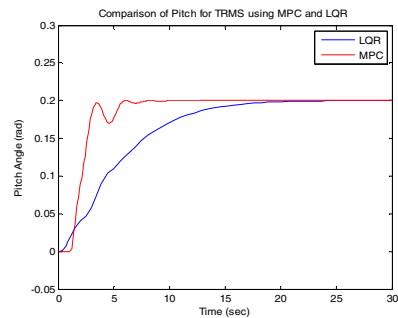

Figure 7: Comparison of Pitch angle output for TRMS using MPC and LQR

The settling time of MPC controller is around 6 seconds while that of LQR controller is 17 seconds. Rise time for MPC is 4.5 seconds while for LQR it is 15 seconds.

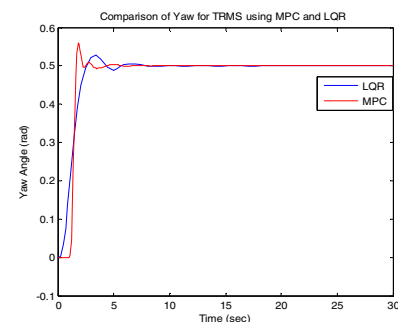

Figure 8: Comparison of Yaw angle output for TRMS using MPC and LQR

The settling time for MPC is 2 seconds while for that of LQR is 6 seconds. Rise time for MPC is around 1 second while for LQR is 2.5 seconds. From the simulation results it becomes obvious that the response of TRMS using MPC is improved as compared

to LQR. MPC transited the TRMS to reach to the desired steady state position in smaller duration as compared to LQR with better stability.

5. Conclusion

In this paper a two degree of freedom TRMS system is considered. It is concluded that TRMS is a good approximating model for Helicopter. MATLAB/Simulink is used for the simulation of TRMS. A state-space model is developed from the governing equations of TRMS. The open loop impulse & step responses of Pitch & Yaw are highly unstable. However, the system is fully controllable & observable. A robust & optimal Model Predictive Controller is designed for the TRMS. Using step input as set points for both Pitch & Yaw, the performance of the designed controller for TRMS has been evaluated. By comparing the performance of MPC controller with LQR controller for TRMS, it is observed that settling time and rise time are minimum for MPC as compared to LQR controller.

6. References

- [1] S. K. Pandey and V. Laxmi, "Optimal Control of Twin Rotor MIMO System Using LQR Technique," in *Computational Intelligence in Data Mining-Volume 1*, ed: Springer, 2015, pp. 11-21.
- [2] A. Q. Khan and N. Iqbal, "Modeling and design of an optimal regulator for three degree of freedom helicopter/twin rotor control system," in *Engineering, Sciences and Technology, Student Conference On*, 2004, pp. 45-50.
- [3] K. U. Khan and N. Iqbal, "Modeling and controller design of twin rotor system/helicopter lab process developed at PIEAS," in *Multi Topic Conference, 2003. INMIC 2003. 7th International*, 2003, pp. 321-326.
- [4] T.-S. Kim, J.-H. Yang, Y.-S. Lee, and O.-K. Kwon, "Twin rotors system modeling and bumpless transfer implementation algorithm for LQ control," in *SICE-ICASE, 2006. International Joint Conference*, 2006, pp. 114-119.
- [5] B. Pratap, A. Agrawal, and S. Purwar, "Optimal control of twin rotor MIMO system using output feedback," in *Power, Control and Embedded Systems (ICPCES), 2012 2nd International Conference on*, 2012, pp. 1-6.
- [6] S. F. Toha, S. Julai, and M. O. Tokhi, "Ant colony based model prediction of a twin rotor system," *Procedia Engineering*, vol. 41, pp. 1135-1144, 2012.
- [7] S. Ahmad, A. Chipperfield, and M. Tokhi, "Dynamic modelling and open-loop control of a twin rotor multi-input multi-output system," *Proceedings of the Institution of Mechanical Engineers, Part I: Journal of Systems and Control Engineering*, vol. 216, pp. 477-496, 2002.
- [8] P. Wen and Y. Li, "Twin rotor system modeling, decoupling and optimal control," in *Mechatronics and Automation (ICMA), 2011 International Conference on*, 2011, pp. 1839-1842.
- [9] P. W. Te-Wei, "Time Optimal and robust control of Twin rotor system," in *Proc. of*, 2007.
- [10] J. Juang, M. Huang, and W. Liu, "PID control using prescribed genetic algorithms for MIMO system," *IEEE Transaction on Systems, Man and Cybernetics*, pp. 716-727.
- [11] J.-G. Juang, R.-W. Lin, and W.-K. Liu, "Comparison of classical control and intelligent control for a MIMO system," *Applied Mathematics and Computation*, vol. 205, pp. 778-791, 2008.
- [12] J.-G. Juang, W.-K. Liu, and R.-W. Lin, "A hybrid intelligent controller for a twin rotor MIMO system and its hardware implementation," *ISA transactions*, vol. 50, pp. 609-619, 2011.
- [13] C.-W. Tao, J.-S. Taur, Y.-H. Chang, and C.-W. Chang, "A novel fuzzy-sliding and fuzzy-integral-sliding controller for the twin-rotor multi-input-multi-output system," *Fuzzy Systems, IEEE Transactions on*, vol. 18, pp. 893-905, 2010.
- [14] C.-W. Tao, J.-S. Taur, and Y. Chen, "Design of a parallel distributed fuzzy LQR controller for the twin rotor multi-input multi-output system," *Fuzzy Sets and Systems*, vol. 161, pp. 2081-2103, 2010.
- [15] M. Saeki, J.-i. Imura, and Y. Wada, "Flight control design and experiment of a twin rotor helicopter model via 2 step exact linearization," in *Control Applications, 1999. Proceedings of the 1999 IEEE International Conference on*, 1999, pp. 146-151.
- [16] G. Mustafa and N. Iqbal, "Controller design for a twin rotor helicopter model via exact state feedback linearization," in *Multitopic Conference, 2004. Proceedings of INMIC 2004. 8th International*, 2004, pp. 706-711.
- [17] B. Pratap and S. Purwar, "Sliding mode state observer for 2-DOF twin rotor MIMO system," in *Power, Control and Embedded Systems (ICPCES), 2010 International Conference on*, 2010, pp. 1-6.
- [18] F. A. Shaik and S. Purwar, "A nonlinear state observer design for 2-dof twin rotor system using neural networks," in *Advances in Computing, Control, & Telecommunication Technologies, 2009. ACT'09. International Conference on*, 2009, pp. 15-19.
- [19] H. K. Khalil, "Adaptive output feedback control of nonlinear systems represented by input-output models," *Automatic Control, IEEE Transactions on*, vol. 41, pp. 177-188, 1996.
- [20] P. Wen and T.-W. Lu, "Decoupling control of a twin rotor MIMO system using robust deadbeat control technique," *IET Control Theory & Applications*, vol. 2, pp. 999-1007, 2008.
- [21] J. B. Rawlings, "Tutorial overview of model predictive control," *Control Systems, IEEE*, vol. 20, pp. 38-52, 2000.
- [22] A. Bemporad, "Model predictive control design: New trends and tools," in *Decision and Control, 2006 45th IEEE Conference on*, 2006, pp. 6678-6683.
- [23] A. Bennoune, A. Kaddouri, and M. Ghribi, "Application of the dynamic linearization technique to the reduction of the energy consumption of induction motors," *Appl. Math. Sci*, vol. 1, pp. 1685-1694, 2007.
- [24] S. K. Pandey and V. Laxmi, "Control of twin rotor MIMO system using PID controller with derivative filter coefficient," in *Electrical, Electronics and Computer Science (SCECS), 2014 IEEE Students' Conference on*, 2014, pp. 1-6.