

Design and Implementation of an ARM Based Embedded System for Pedestrian Dead Reckoning

Süleyman Urmat[§], Müştak Erhan Yalçın[‡]

Istanbul Technical University, Faculty of Electrical and Electronics Engineering,
Electronics and Communication Engineering Department, 34469, Maslak/Istanbul, Turkey

surmat@itu.edu.tr[§], yalcinmust@itu.edu.tr[‡]

Abstract

The work presented in this paper includes the design and implementation of an ARM based embedded system for PDR with MARG measurement units such as three axes accelerometer, gyroscope and magnetometer. PDR system is based on 32-bit ARM Cortex-M3 low power processor and including 9-axes MEMS sensor unit, GNSS module with BLE and two concurrent ISM band transceivers is designed as a portable development platform. Step detection, step length estimation and orientation estimation methods are evaluated and combined as PDR model. We estimate the pedestrian walking position in a scenario where sensor be placed on the hip. PDR system was tested and experimental results of the tests are shown.

1. Introduction

The Global Navigation Satellite System (GNSS) provide location services with high accuracy for outdoor areas meanwhile indoor positioning is still an unresolved issue. Obtaining location information is impossible when the GNSS signals are degraded dramatically or lost. Furthermore, indoor localization and dead reckoning are the current open issues caused by the given. The systems which use dead reckoning techniques are generally used as supplementary unit to keep supplying location data even when the live connection with the GNSS is lost. The dead reckoning applications are established by utilizing different sources such as Wireless Fidelity (WIFI), Bluetooth, Sub 1 GHz Industrial Scientific Medical (ISM) band radio frequency (RF) transceivers and Microelectromechanical Systems (MEMS) to increase reliability of the generated location data [1, 2].

Sensor units are manufactured by the growing MEMS technology which is used in various fields and applications recently. MEMS sensors have many advantages which are low cost, small size package, lighter weight, stable structure, low power consumption and easy to integrate into manufacturing process. The worst feature of MEMS sensor is that is not as sensitive as optical devices [3, 4, 5].

Dead reckoning is a system that can specify the location using a priori known starting positioning related with velocity-time variables. Location estimation which is committed under the scenario that is location of the pedestrians changes while

walking, is named as Pedestrian Dead Reckoning (PDR). The PDR systems consist of two fundamental section step detection and orientation estimation. In order to detect the number of steps, generally three axes accelerometer sensor is used as sensor via the zero-crossing detection or peak detection methods as the step detection methods [2, 3, 6]. In addition to this gyroscope data also provides the results with high accuracy in order to determine the number of steps. Furthermore, the orientation estimation can be obtained with accelerometer, magnetometer and gyroscope sensors [7, 8].

As the need for the PDR application increases in many areas. Accelerometer, magnetometer and gyroscope sensors take a critical role for that. Inertial Measurement Unit (IMU) which consists of accelerometer and gyroscope sensors, is used to track and determine the rotational motion in dead reckoning systems. If the complete measurement is made aligning with the direction of gravity; Magnetic, Angular rate, Gravity (MARG) is used with the magnetometer that measures Earth's magnetic field. In addition, MARG is comprised of 3 axes accelerometer, 3 axes gyroscope, and 3 axes magnetometer. MARG unit is named as 9 axes sensor unit [9, 10].

Making right orientation estimation is crucial for PDR systems. Errors encountered during the orientation estimation can make the location detection system non-functional. The orientation estimation with high accuracy should minimize these errors. To minimize these errors, the sensor calibration is inevitable. There are many parameters for calibration such as miss-alignment, scale factor, bias etc. Although 9 axes MARG sensor units are calibrated, they still cause errors for PDR systems. Major reasons of that are both cumulative errors of gyroscope sensor over the system and not choosing a proper filter in nature of motion of rotation. Obviously, couple of accelerometer-magnetometer provide more accurate results under the stationary or slow transitions than gyroscope however gyroscopes are rather accurate at a dynamic transition. Right choice of the sensor depending on the motion gains importance while the orientation estimation. There are several algorithms or filters such as Kalman Filter, Complementary Filter, Fast Adaptive-Gain Orientation Filter etc. which are carried on to compensate these errors [9, 11, 12].

This work includes the details of the design and implementation of an Acorn RISC Machine (ARM) based embedded system which estimates the location of pedestrians with MARG sensors made with MEMS technology attached to body. The step detection, step length, attitude and heading reference can be estimated by collecting the data from MARG sensor unit.

This work was supported by the ITU Arařtırmacı Yetiřtirme Programı (ITU-AYP).

Before the estimation process the raw sensor data is calibrated and then the calibrated sensor data is used for orientation estimation. The peak detection algorithm is used as a step detection algorithm in this work. For the part of the orientation estimation, orientation is expressed with quaternion representation. Madgwick's orientation filter is used for the estimating the orientation and sensor fusion [9].

This paper is prepared as follows. Section 2 will introduce the hardware design and configuration of the PDR system. Section 3 will explain the sensor calibration, step detection, length estimation and orientation estimation for Dead Reckoning (DR) systems. In section 4 the designed PDR system will be confirmed by the experiment which is intended for location estimation. At last section, the paper is finished with conclusion.

2. The Design and Configuration of the System

A new board that is based on 32-bit low power processor and including 9-axis MEMS sensor unit, GNSS module with Bluetooth low energy (BLE) and two concurrent ISM band transceivers is designed as a portable development platform. The details of the hardware configuration which consist of 32-bit ARM Cortex-M3 micro-controller, 9 axes MARG sensor unit, GNSS (supports global position system (GPS), GLONASS, GALIEO and BeiDou global satellite positioning services), wireless communication units which are 2.4 GHz BLE, 433 MHz and 868 MHz ISM band RF transceivers and RS422 serial communication converter for monitoring and debugging.

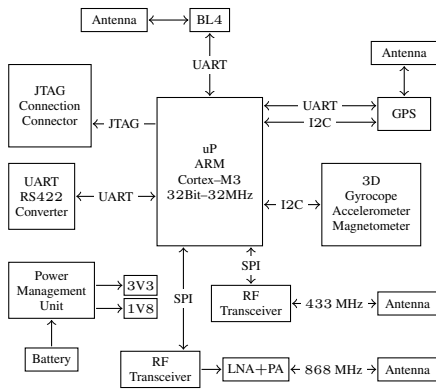

Figure 1. Hardware blocks of PDR system.

Hardware blocks on the designed board consist of power unit, processor unit and RF unit. Light Emitting Diode (LED) light sources and buttons have been positioned on the board as man-machine interface while designing. Furthermore RS422 serial communication connection has been established for obtaining sensor data and monitoring. Altium Designer which has been used for the designing board, is an electronic design automation program for printed circuit boards and embedded hardware design [13].

Debugging and coding are processed via Joint Test Action Group (JTAG) connection on the board. All variables and registers can be read and changed via JTAG interface. JTAG connection on the processor is established with ST-LINK/V2 debugging tool which is owned by ST Microelectronics [14]. This debugging tool can connect to any computer via universal serial bus (USB) cable. Furthermore, it can be worked responsively

with third party development programs.

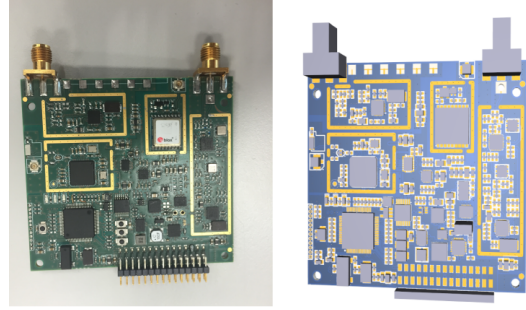

Figure 2. Designed board.

Both control and connection of communication interfaces of peripheral unit around processor have been implied using STM32CubeMX which is owned by ST Microelectronics [15]. Communication interfaces, initializing timers and interrupt service routines can be adjusted by help of this program in the processor. STM32CubeMX program can automatically produce C programming codes of drivers which are at level of hardware for adjusted communication interfaces such Inter-Integrated Circuit (I2C), Serial Peripheral Interface (SPI), Universal Asynchronous Receiver-Transmitter (UART) and interrupts and inputs-outputs. Furthermore time signals of the system can be adjusted making phase-locked loop (PLL) adjustments which belong to units on the processor.

Processor on the designed board operates with 3.3 V supply voltage. 32 kHz crystal with processor core which is in itself, and 8 MHz crystal are used as time signals for real-time clock (RTC) and peripheral units, respectively. Operating frequency of the processor is increased to 32 MHz with PLL block which is in itself. Internal 384 kB flash memory has been chose as memory field of the system.

Many communication interfaces are positioned on the designed system as illustrated in Figure1. Communication between RF circuitries and processor is provided using SPI interface. The processor and transceiver circuitries have been adjusted as master and slave, respectively. Processor controls the RF transceiver according to incoming signals from interrupts. Hardware controlled serial communication interface UART is used to communicate with bluetooth. Communication between processor and bluetooth is adjusted as 8 bit data, none parity, 1 stop bit, and 115200 baud rate. GNSS module has two different communication interfaces. One of these, UART serial communication is adjusted as 8 bit data, none parity, 1 stop bit, and 115200 baud rate. Other communication interface display data channel (DDC) is implied reading 0x42 address at speed of 400 kHz as I2C. 9 axes sensor unit also communicates with the processor at speed of 400 kHz as I2C.

3. PDR System Overview

The following section describes methods that are applied in our experimental study. These methods are sensor calibration, step detection, step length estimation and orientation estimation. Furthermore PDR model is explained in detail.

3.1. Sensor Calibration

Noise and discontinuous points exist on the data which is measured for the each axis for accelerometer, gyroscope, and

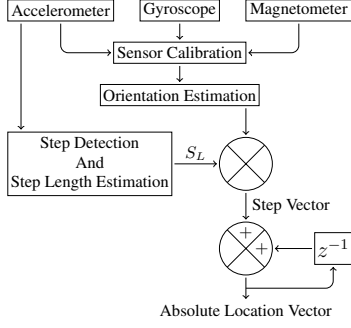

Figure 3. PDR Model.

magnetometer. Processing data in this manner causes errors while making orientation estimation. Apparent affect builds up over time due to cumulative effect of consisted errors. Calibration is necessary to minimize emergent errors. Biases are obtained using mean of the sensor data to calibrate. Obtained biases are subtracted from raw data. Obtained values are filtered with second order low pass Butterworth filter. Both subtracting biases and filtering is implemented for other sensor units which are accelerometer and gyroscope.

3.2. Step Detection

The first stage of walking distance estimation is step detection. There are several methods to detect number of step using accelerometer data. This step detection methods are peak detection method, flat zone detection method, zero crossing detection method and etc [3, 11]. Also x-axis data of gyroscope which is vertically located on the pocket is used in the some algorithm [8, 16]. In order to detect and count steps, both the peak detection and zero crossing detection are used via using accelerometer data.

Norm of 3-axes accelerometer signals is used to detect number of steps with high accuracy like following equation [3, 17, 18, 19].

$$a_{3D} = \sqrt{a_x^2 + a_y^2 + a_z^2} \quad (1)$$

a_{3D} is norm of 3-axis acceleration value. a_x , a_y and a_z are acceleration values of x , y and z axes by the given sequence.

Acceleration values include gravity component. Therefore mean of norm of acceleration should be subtracted from norm of acceleration values as following equation to determine linear acceleration [17, 18]. By the way we can detect zero crossing of 3-axes accelerometer signals.

$$a_{3D} = a_{3D} - \frac{\sum_{i=1}^n a_{3D}(i)}{n} \quad (2)$$

Accelerometer sensor values include incorrect measurement components and noise. Step detection methods are considerably affected by incorrect measurement components and noise. As a result we count wrong footsteps [3, 18]. We used an 8-sample moving average filter and canceled noise and incorrect measurement components in order to improve accuracy of step detection [11].

$$a_{3D}(n) = \frac{1}{8} \sum_{i=n-8}^N a_{3D}(i) \quad (3)$$

We used peak detection and zero crossing detection to detect the step in this algorithm in order to improve accuracy of step detection [3]. When the differences of amplitude of peak values and amplitude of valley values are more than threshold and zero crossing occurs sequentially, this algorithm counts steps correctly. Threshold value depends on walking speed. For the future it is possible to use adaptive system based on walking speed for updating the threshold. On the other hand, that option increases computational load and our algorithm may become slower.

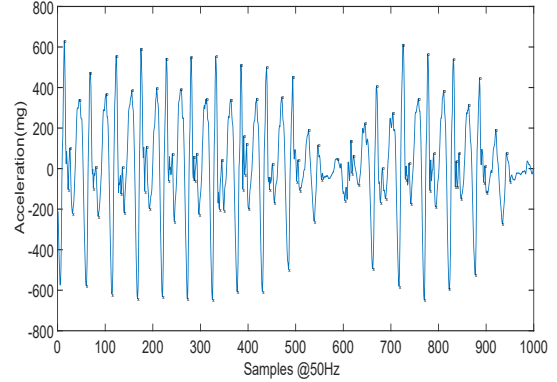

Figure 4. Step Detection.

3.3. Step Length Estimation

The other stage of walking distance estimation is step length estimation. Step length estimation depends on different parameters such as step frequency, obstacles and ground. Step length is a distance covered between the heel to heel during walking. There are two common methods [3, 19].

The first method is a linear step length estimation. Following equation shows linear step length estimation [11, 18, 19].

$$S_L = a + b.f_s + f_v c \quad (4)$$

S_L , f_s , f_v and a , b , c are step length, step frequency, variance of acceleration and constant parameters which are determined by training.

The other method is a non-linear step length estimation. Following equation shows non-linear step length estimation [2, 3, 11, 19].

$$S_L = k \sqrt[4]{a_{3D,max} - a_{3D,min}} \quad (5)$$

S_L , $a_{3D,max}$, $a_{3D,min}$ and k which are step length, maximum acceleration value, minimum acceleration value and constant value of the step length [2, 3, 11]. In order to determine constant k where take some experiments through walking in range of known distance. After that distance is divided by detected number of steps and k is determined.

Non-linear step length estimation is used to obtain the step length. As non-linear model has single parameter hence it is easy to determine and implement for real time applications [3, 9].

3.4. Orientation Estimation

The orientation of any object can be obtained under favour of accelerometer, gyroscope and magnetometer sensors. Internal sensor units can perform measurements at the sensor frame

system with accelerometer, gyroscope and magnetometer. Acceleration at the orientation of any object can be obtained using accelerometer both stationary acceleration (gravity) and linear acceleration which is originating from motion of object at three axes. Resultant angular velocity at each three axes is computed using gyroscope and then Earth's magnetic field is obtained measuring magnetic field at each three axes under favour of magnetometer [9].

Two different orientation is obtained using both gyroscope and accelerometer-magnetometer while making orientation estimation. The orientation which will be used to compensate for obtained orientation errors using gyroscope, is obtained by accelerometer and magnetometer. One of the primary reasons of errors caused by gyroscope results in critical bias on the system in time even if they are stable due to their dynamic structure. Accelerometer and magnetometer are used to compensate these errors. Obtained orientation using gyroscope is determinant while whirling.

The quaternion representation is a four dimensional complex vector which is used to express the orientation body fixed or coordinate frame in the three dimensional space. Quaternion method is used to defined rotation the between sensor frame and Earth frame. The quaternion which is basically expressed as a rotation axis \hat{u} and angle γ . The following equation express the orientation of Earth frame to sensor frame by using quaternion [20].

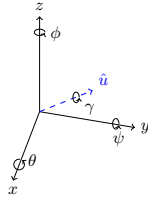

Figure 5. Euler angles and axis.

$${}^S_E \hat{q} = [q_1 \quad q_2 \quad q_3 \quad q_4] \quad (6)$$

The rotation matrix can be shown as the following equation by the orientation between Earth frame and sensor frame.

$${}^S_E R(q_1, q_2, q_3, q_4) = \begin{bmatrix} 2q_1^2 - 1 + 2q_2^2 & 2q_2q_3 + 2q_1q_4 & 2q_2q_4 - 2q_1q_3 \\ 2q_2q_3 - 2q_1q_4 & 2q_1^2 - 1 + 2q_3^2 & 2q_3q_4 + 2q_1q_2 \\ 2q_2q_4 + 2q_1q_3 & 2q_3q_4 - 2q_1q_2 & 2q_1^2 - 1 + 2q_4^2 \end{bmatrix} \quad (7)$$

The filter which is used for the orientation estimation, has the same structure with implied filter by Madgwick. Madgwick's model is given [9] in Figure 6 having the same notation with [9]. The filter provide making orientation estimation by combining two orientation estimations obtained with both gyroscope and accelerometer-magnetometers corresponding to their weights.

3.5. Pedestrian Dead Reckoning Model

PDR model consists of four separate blocks, sensor calibration, orientation estimation, step detection and length estimation. So as to determine pedestrian movement, it should be known when the step occurs, step length and finally heading angle. With respect to these parameters, in a reference coordinate frame such as Cartesian coordinate system, the movement

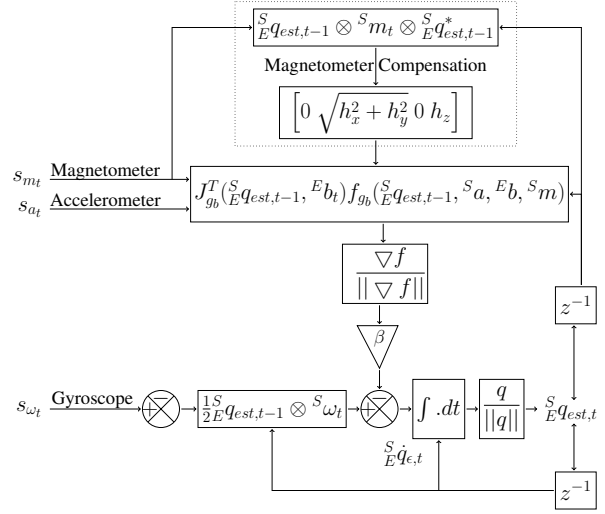

Figure 6. Madgwick's model.

of pedestrian can be calculated with known initial condition x_0 and y_0 by the following equation [21].

$$x_{n+1} = x_n + S_L(n) \cos(\theta) \quad (8)$$

$$y_{n+1} = y_n + S_L(n) \sin(\theta) \quad (9)$$

The heading angle is extracted from orientation filter in favor of accelerometer, gyroscope and magnetometer. Meanwhile step detection and length estimation are obtained from accelerometer. The results of each block can be combined and that makes possible determining of the step vector. Finally all the step vectors gathered when step occurs form the trajectory.

4. Experiment

PDR system was mounted on the hip and powered through laptop's USB port. All the sensors' outputs sampled at 50 Hz and recorded by the cabled over RS422 serial communication connection as dataset.

The evaluation methodology is determined as comparing PDR system with respect to ground truth. The performance of the PDR system was shown by position errors. The track walked during test was 18.7 m x 7.35 m square area. The experiment results were given that estimated step length, estimated step counts and totally estimated distance were 0.671 m, 79 and 53.25 m respectively.

Distance Error (m)–(%)	Max. Avg. Positioning Error (m)–(%)	Step Count Error (%)
1.15–2.2	2.08–4	3.65

Table 1. PDR system errors.

5. Conclusion

This paper shows the design and implementation of PDR system with experimental study. In addition, PDR methods such as step detection, length estimation, orientation estimation and positioning are investigated and evaluated with MARG sensor units. The performance of the PDR system is analyzed with

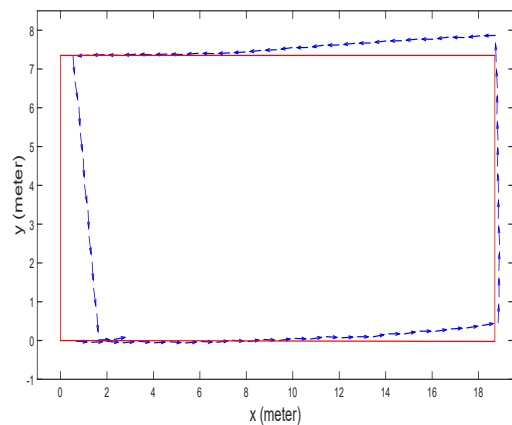

Figure 7. Experiment trajectory and estimated track.

experiment. According to the results of experiment is verified as 2.2% distance error, 4% maximum average positioning error and 3,65% step count error. The results are enough good for short range distances. On the other hand, for the medium and long range cumulative errors of PDR system will be increased. For the future work, performance of PDRs systems should be enhanced and developed by advanced techniques for sensor calibration, increasing accuracy of orientation filters and sensor fusion algorithms.

6. References

- [1] H. Leppäkoski, J. Collin and J. Takala, “Pedestrian navigation based on inertial sensors, indoor map, and WLAN signals”, in *Acoustics, Speech and Signal Processing (ICASSP), 2012 IEEE International Conference on*, March, 2012, pp. 1569–1572.
- [2] Z. Yu, “Dead Reckoning Algorithms For Indoor Localization”, *Dept. of Electrical & Computer Eng., NUS, Singapore*, 2012.
- [3] Y. K. Kim, S. H. Choi, H. W. Kim and J. M. Lee, “Performance improvement and height estimation of pedestrian dead-reckoning system using a low cost MEMS sensor”, in *Control, Automation and Systems (ICCAS), 12th International Conference on*, 2012, pp. 1655–1600.
- [4] Batista, S. Pedro, O. Carlos, C. Paulo and Bruno, “Accelerometer calibration and dynamic bias and gravity estimation: Analysis, design, and experimental evaluation”, *IEEE Transactions on Control Systems Technology*, vol. 19, no. 5, pp: 1128–1137, 2012.
- [5] O. J. Woodman, “An introduction to inertial navigation”, *University of Cambridge, Technical Report*, 2007.
- [6] U. Steinhoff and B. Schiele, “Dead reckoning from the pocket – An experimental study”, in *Pervasive Computing and Communications (PerCom), 2010 IEEE International Conference on*, 2010, pp. 162–170.
- [7] J. S. Sheu, G. S. Huang, W. C. Jheng and C. H. Hsiao, “Design and implementation of a three-dimensional pedometer accumulating walking or jogging motions”, in *International Symposium on Computer, Consumer and Control*, June, 2014 pp. 828–831.
- [8] S. Jayalath, N. Abhayasinghe and I. Murray, “A Gyroscope Based Accurate Pedometer Algorithm” in *2013 International Conference on Indoor Positioning and Indoor Navigation*, 2013.
- [9] S.O.H. Madgwick, A.J.L. Harrison and R. Vaidyanathan, “Estimation of IMU and MARG orientation using a gradient descent algorithm”, in *Rehabilitation Robotics (ICORR), 2011 IEEE International Conference on*, June, 2011, pp. 1–7.
- [10] J. S. Hu and K. C. Sun, “A Robust Orientation Estimation Algorithm Using MARG Sensors”, *Instrumentation and Measurement, IEEE Transactions on*, vol. 64, no. 3, pp: 815–822, March, 2015.
- [11] P. E. Q. Garcia and W. Li, “On Indoor Positioning for Mobile Devices”, *Dept. of Signals and Systems, CTH, Göteborg*, 2011.
- [12] R. Mahony, T. Hamel, J. M. Pflimlin, “Nonlinear Complementary Filters on the Special Orthogonal Group”, *Automatic Control, IEEE Transactions on*, vol. 53, no. 5, pp: 1203–1218, June, 2008.
- [13] Altium Designer, (2015, May 02nd). Available: <http://www.altium.com/altium-designer/overview>
- [14] ST-LINK/V2, (2015, May 02nd). Available: <http://www.st.com/web/en/catalog/tools/PF251168>
- [15] Texas Instruments Company, (2015, May 02nd). Available: <http://www.ti.com/lit/ds/symlink/cc2564.pdf>
- [16] S. Jayalath, N. Abhayasinghe, “A Gyroscopic Data based Pedometer Algorithm”, in *Computer Science Education (ICCSE), 2013 8th International Conference on*, 2013, pp. 551–555.
- [17] M.N. I. Bonilla, P. J. Escamilla-Ambrosio, and J. M. R. Cortes, “Pedestrian dead reckoning towards indoor location based applications”, in *Electrical Engineering Computing Science and Automatic Control (CCE), 2011 8th International Conference on*, 2011, pp. 1–6.
- [18] D. Pai, M. Malpani, I. Sasi, N. Aggarwal and P. S. Mantripragada, “Padati: A Robust Pedestrian Dead Reckoning System on Smartphones”, in *Trust, Security and Privacy in Computing and Communications (TrustCom), 2012 IEEE 11th International Conference on*, 2012, pp. 2000–2007.
- [19] J. Park, Y. Kim and J. Lee, “Waist Mounted Pedestrian Dead-Reckoning System”, in *Ubiquitous Robots and Ambient Intelligence (URAI), 2012 9th International Conference on*, 2012, pp. 335–336.
- [20] B. Dam, M. Koch and M. Lillholm, “Quaternions, Interpolation and Animation”, *University of Copenhagen, Technical Report*, 1998
- [21] J. O. Eriksson and L. H. Tengfjord, “Indoor Positioning for Mobile Devices using Instrumentation and Dead Reckoning”, *Dept. of Signals and Systems, Chalmers University of Technology, Göteborg*, 2014.