

Measuring of Diaphragm Movements by using iMEMS Acceleration Sensor

H. Sumbul¹, A. Hayrettin Yuzer²

¹Ondokuz Mayıs University, Yesilyurt D.C. Vocational School,
Samsun, Turkey
harun.sumbul@omu.edu.tr

²Karabuk University Engineering Faculty, Department of Electrical and Electronics Engineering,
Karabuk, Turkey
hayrettinyuzer@karabuk.edu.tr

Abstract

With the development of technology, in the diagnosis of many diseases, electrical signals measured from different points on the human body, offered to doctors by making meaningful with the help of different algorithms. This is quite important for both safer for the patient to be diagnosed more quickly. This paper presents a data acquisition system which has ability to measure and record the movement of diaphragm. The developed measuring device was connected on the five patients whose have different features (age, tall, weight) and the diaphragm movements were monitored. It is showed that the shape of recorded data by the developed system is similar to shape of recorded data by using industrial spirometer instrument. Besides breathing signal, some parameters (FVC, TVC) that play an important role in the detection of some diseases such as COPD also has been obtained and shared at the measurement results section. As a results, our developed system seems to measure and record the breathing movements and some respiratory parameters with great reliability and inexpensive, portable, easy to use.

1. Introduction

All living creatures must constantly breathe in order to continue their living. The breathing which is indispensable for living creatures is provided by contraction of the diaphragm muscle layer that separates the abdominal and chest cavity. The diaphragm size varies during the inspiration and expiration. Changing in the diaphragm size which is associated with respiratory muscles, may be to have an idea about many diseases (the diaphragm eventration, lower lobe atelektezi, dyspnea, chronic obstructive pulmonary disease (COPD), sleep apnea etc.) by monitoring the changes [1], [2].

Diagnosis of COPD is not easy. The process of diagnosis of COPD takes a long time and requires complex high-cost diagnostic technical details, because there are many parameters related to diaphragm such as FEV, tidal volume capacity (TVC), slow vital capacity (SVC), forced vital capacity (FVC), forced expiratory volume in 1 second (FV1), forced expiratory volume in 6 second (FV6) and total lung capacity (TLC) etc.

Recording of the diaphragm movements can be anatomic or functional. Although all radiologic modalities can be used for anatomic imaging. Functional imaging is mainly performed with fluoroscopy, ultrasonography (US), magnetic resonance imaging (MRI), Computerized Tomography (CT) or radiography.

However, the most commonly used method especially for asthma, COPD, etc. in the diagnosis of disease is pulmonary function tests (PFT) method. Most of the both in private and government hospitals, the device called Spirometry [12] is used in PFT. The methods called as recording of the diaphragm movements either anatomic or functional in the PET are described in [3]-[11].

There are some difficulties in the analysis and some of these methods using today have some defects which are not constant for all techniques such as ultrasound. Likewise, the worst part of CT usage is the negative long-term effects of radiation and the risk of dying due to cancer which is directly associated with CT. Since MR analysis and fluoroscopy are expensive as well as irritate the patients, they are not recommended in routine use.

There is a clear need for alternative methods to assess the volume of lung of patients who has faced with problem to do forced spirometry [12]. Especially for the elderly and children, this process is very cumbersome, so the developed system seems to record the breathing movement at the level of the diaphragm with great reliability. Also the developed system is inexpensive, easy to use and clean.

2. Methods

2.1. iMEMS Acceleration Sensor

iMEMS semiconductor technology combines micromechanical structures and electrical circuits on a single silicon chip. Using this technology, iMEMS accelerometers sense acceleration on one, two or even three axes, with analog or digital outputs. Depending on the application, the accelerometer may offer different ranges of detection, from several "g" to tens of "g". Digital versions may even have multiple interrupt modes. These features offer the user convenient and flexible solutions.

The ADXL345 is an iMEMS 3-axis accelerometer with digital output. It features a selectable ± 2 -g, ± 4 -g, ± 8 -g, or ± 16 -g measurement range; resolution of up to 13 bits; fixed 4-mg/LSB sensitivity; a tiny 3-mm \times 5-mm \times 1-mm package; ultralow power consumption (25 μ A to 130 μ A); standard I2C and SPI serial digital interfacing; and 32-level FIFO storage. A variety of built-in features, including motion-status detection and flexible interrupts, greatly simplify implementation of the algorithm for fall detection [13]. Hence, this combination of features makes the ADXL345 an most appropriate accelerometer to observing the movements of diaphragm for our study. iMEMS accelerometers that are used from military areas to health care industry have been explained in [14]-[17].

2.2. Diaphragm Movements

Information about the movement of the diaphragm during respiration is useful for many medical imaging applications [18],[19]. In order to observe the movements of the diaphragm during respiration, despite the used methods such as direct graphy, fluoroscopy, ultrasound, computed tomography and dynamic MRI, the proposed method may be considered as an alternative method due to practical, less costly, the portable and useful.

The designed system is placed on a body so as to xz-plane lie parallel to the ground as shown in Fig. 1 and the z-axis is positioned perpendicular to the diaphragm. Hence, changing in the z axis shows directly diaphragm movement. In order to obtain reliable results during the diaphragm movement measurement patient is assumed not to move.

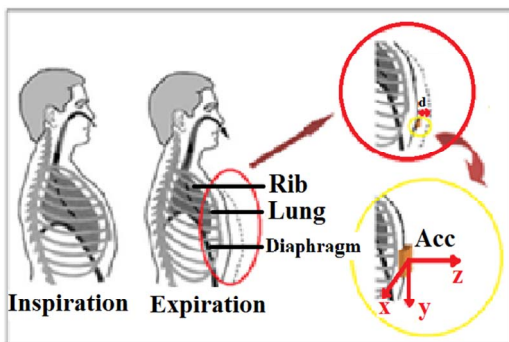

Fig. 1. Acceleration sensors to be placed on the diaphragm [20]

Motion of the diaphragm is principally axial, so a three-axis acceleration sensor is preferred. In the designed system, due to the diaphragm movement is greater than the movement of the thorax (d distance variations), measurements were taken from the diaphragm area.

3. Protocol and Measurement Device

Data measuring and recording system's hardware consists of two parts;

- Microcontroller based data acquisition unit
- Data transfer unit

Fig. 2 shows a block diagram of the designed and realized system.

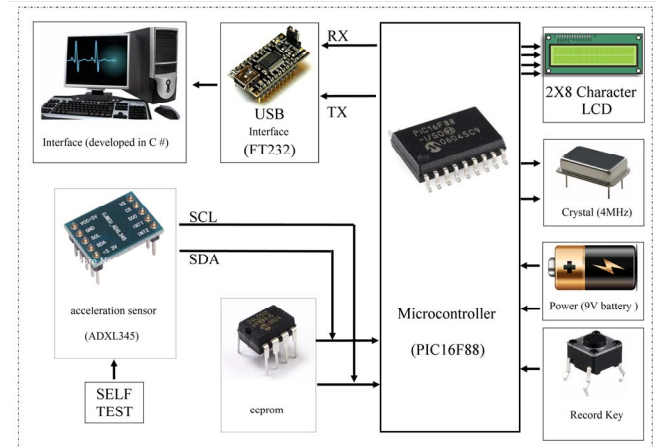

Fig. 2. The block diagram of designed and realized system

Sampling frequency is 20Hz. Each 32-bits of float received data are composed of x, y and z data. Thereby, the amounts of data transferred are $20 \times 3 \times 32 = 1920$ bits / sec and it is suitable for a wireless transmission. As it is seen from Fig. 2, the system is capable of being improved.

The circuit of the system includes PIC16F88 microcontroller, 2x8 character LCD display, accelerometer sensor, eeprom memory component and data transfer circuit card. The required power for the entire circuit has been obtained from a circuit containing a 9V battery and LM7805 regulator. In the designed system, ADXL345 is taken out by a plug in order to increase X, Y and Z axis acceleration measurement sensitivity. Some of important features of the designed system can be summarize as easy to use, light weight and small size, portability, low power consumption characteristics.

Microcontroller and interface program is prepared by using Microsoft Visual C# 2010 (version 10.0.40219.1 SP1Rel) programming language. In addition to this, MATLAB program (version 7.12.0.635 (R2011a) 32-bit win32) has been also used for data interpretation and filtering.

An interface program is developed as given in Fig. 3 in order to transfer the acceleration values (X, Y and Z) to the computer. The interface program consists of a lot of parts such as; system date and clock, save button, import data button, connect button, exit button, plotting and filtering. Meanwhile, the interface program provides opportunities to save the data measured as a text file or to plot the graph of the previously recorded data.

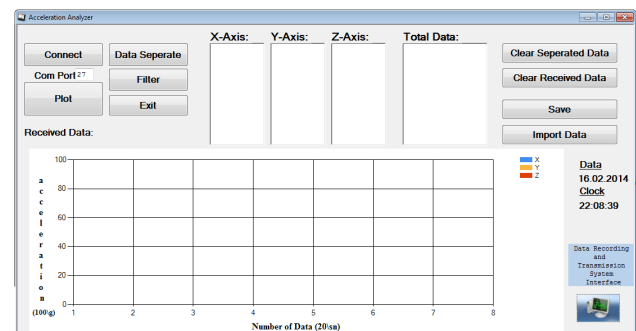

Fig. 3. Interface program (prepared by using C # programming language commands)

4. Measurement Results

Five measurement have been performed over five different patients who have different features (age, tall and weight) and then the diaphragm movements were monitored as given in Fig. 4 while tidal breathing. The first and the third patient have excess weight (having over fat layer than normal people). Those patients' fat layers have influenced the measurement result.

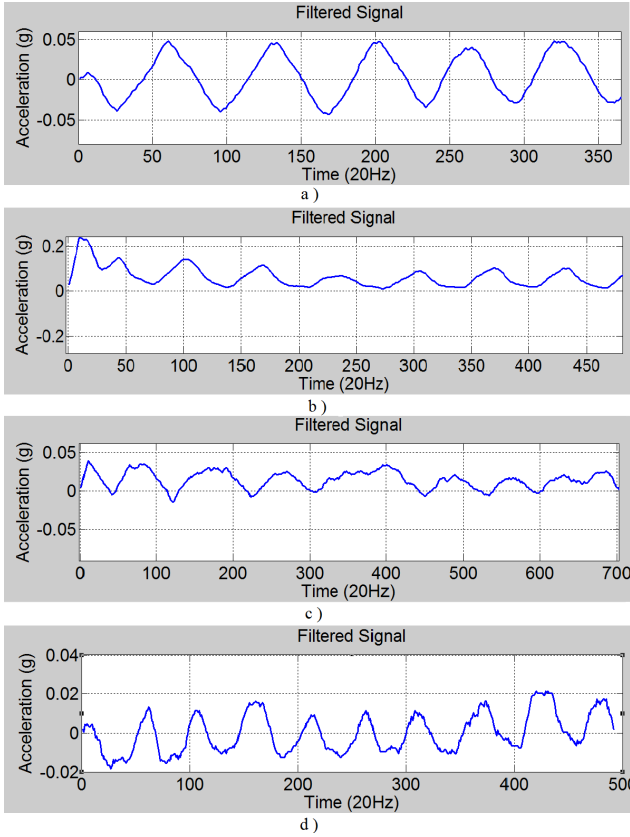

Fig. 4. The different movements of the diaphragm measuring patterns: a) age: 64, tall: 180cm, weight: 105kg; b) age: 25, tall: 190 cm, weight: 90 kg; c) age: 51 tall:185 cm, weight:110 kg; d) age:31 tall:180 cm weight:80 kg.

Graphical representation of the most common parameters measured in spirometry are given in Fig. 5[21].

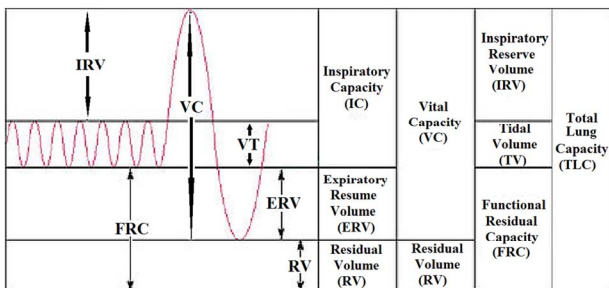

Fig.5. The most common parameters measured in spirometry

A patient's diaphragm movements are measured by using

both the developed accelerometer-based systems and industrial spirometer (Prg ver: 2.36B 16-Bit) (Fig. 6) in order to show performance of the developed system. The measured parameters are tidal breathing (tidal volume capacity: TVC) and FVC. Experiments were carried out under the supervision of the dedicated technician at 19 Mayıs University, Faculty of Medicine, Pulmonary and Critical Care, Pulmonary Function Tests laboratory.

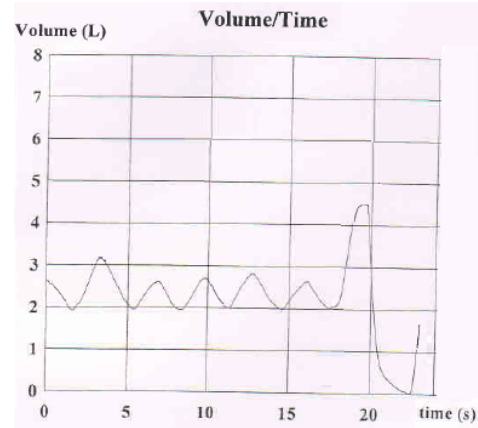

Fig. 6. TVC (0sec - 16sec) and FVC (16sec-) measurement results from industrial spirometer

After applying the 10 point averaging and low-pass filtering in order to get rid of high-frequency noise component in the measured signal, industrial instrument and the designed system measurement results are plotted on the same graph as seen in Fig. 7.

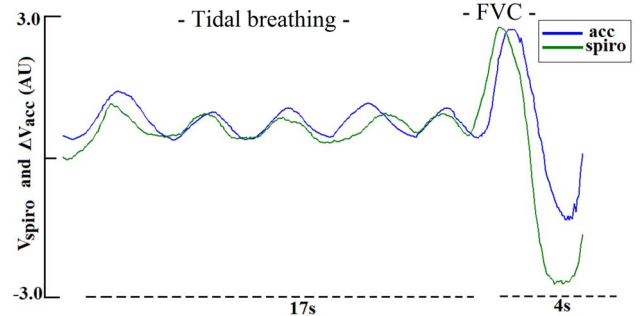

Fig. 7. TVC and FVC measurement results of industrial spirometer (green) and the developed system (blue).

The developed system measurement result is mostly overlapped with the industrial spirometer measurement result. In order to make good comparison between industrial spirometer result and the developed system result, measurement data are listed in Table I and Table II.

Table 1. The mean values of measured parameters

	Spirometric	Accelerometric	Difference
TVC	0.0282	0.0241	14.5%
FVC	0.113	0.109	3.5%

The measurement result of respiration showed highly similar curves for both methods (spirometer and the developed the

system) as seen from Table I. The values obtained for Tidal breathing; while the mean values of spirometric is 0.0282, the mean values of accelerometric is 0.0241. Difference is 0.0041(14.5%) and this difference is assumed as an acceptable value.

'FEV1, FVC and FEV1/FVC are the most important indicators of obstructive diseases in a pulmonary function test. Although in the present study, FEV1, FVC, and FEV1/FVC values were lower in overweight, obese and morbidly obese subjects, the difference was not statistically significant. It was also found that the overweight, obese and morbidly obese children and adolescents had no obstructive impairment compared to healthy ones'[22].

Table 2. Measured parameters details during inspiration and expiration.

	Industrial Spirometer	The Developed System
	Volume (L)	Acceleration (g)
Expiration	1.988	0.327
Inspiration	2.787	0.456

In table II, the average values of the measured values volume (v) and acceleration (g) during inspiration and expiration are given. Simple proportionality rule was used to gain a better understanding of the significant relationship between the two values and difference is 0.00242 and this is an acceptable value.

5. Discussion

As a result in this study, a measurement system is designed and realized in order to monitor and save the movement of the diaphragm during respiration by using iMEMs based accelerometer. The respiratory frequency was correctly determined (Fig. 7) from the measured values of acceleration. As a result of the experiments, breathing frequency is very close to the called normal range area in studies described in [3]–[11]. As a further study, the determination of some diseases associated with the diaphragm like as diaphragm contraction velocity, the volume of air entering the lungs and respiratory failure is planned to be determined with the help of additional equipment. This study also can be used in the diagnosis of sleep apnea disease. This study is considered as secondary method for the available system on pulmonary function tests.

In conclusion, it is proposed that accelerometer sensor method might be used as a reliable tool in the diagnosis of certain diseases mediated diaphragm such as copd, dyspnea, pulmonary hypertension etc. In addition, our method is easy to use and does not contain any danger (e.g. radiation exposure, electromagnetic hazard) and is easy to use and effortless.

6. Acknowledgement

This work is supported by the Coordinatorship of Karabük University's Scientific Research Projects, Karabük, Turkey.

7. References

- [1] G. Fındık, K. Aydoğdu and S.Kaya,"Travma sonrası semptomatik hale gelen diyafraam evantrasyonu", Türk Göğüs Kalp Damar Cer Derg, vol. 19(1), 2011, pp.107-109.
- [2] N. Akyolcu, "Kanserli Hastalarda Dispne Ve Hemşirelik Bakımı", C.Ü. Hemşirelik Yüksekokulu Dergisi,vol. 6(1), 2002, pp.1-8.
- [3] J. J. Froelich, N. Ishaque, J. Regn, B. Saar, E. M. Walthers and K. J. Klose, "Guidance of percutaneous pulmonary biopsies with real-time CT fluoroscopy", European Journal of Radiology vol. 42, 2002, pp.74–79.
- [4] A. Spiker, B.A, Z. Zinn, W. H. Carter, R. Powers and R. Kovach, "Fluoroscopy-Induced Chronic Radiation Dermatitis", The American Journal of Cardiology, Elsevier Inc, 2012, pp:1862-1863.
- [5] L. R. Weld, U. O. Nwoye, R. B. Knight, T. S. Baumgartner, J. S. Ebertowski, M. T. Stringer, M. C. Kasprenski and K. J. Weld, "Fluoroscopy time during uncomplicated unilateral ureteroscopy for urolithiasis decreases with urology resident experience", World J Urol, February, 2014.
- [6] J.-C. M. Richard and L. Brochard, "Sonographic evaluation of the diaphragm in critically ill patients", Technique and clinical applications, Intensive Care Med, May 2013, Volume 39, Issue 5, pp 801-810.
- [7] J.M. A.Azcárate, F. Clau-Terréb, R. Vicho Pereira, M. Guerrero de Mier, A. C. López, A. Ochagavía, J.M. L. Pérez, J. T. Alvarez, L. Pérezi, J.A. Llompert-Pou, F.J. González de Molina, S. Fojón, A. R. Salgado, M.C. M. Díaz, C. R. Villa, F.J. R. Bermejo, M. R.Bailénl, M. A. Díez, M. A. García and J.L. F. Fernández, "Consensus document on ultrasound training in Intensive CareMedicine. Care process, use of the technique and acquisitionof professional skills", Med Intensiva; vol. 38(1), 2014, pp. 33-40.
- [8] V. Cantisani, P. Ricci, H. Grazhdani, A. Napoli, F. Fanelli, C. Catalano, G. Galati, V. D'Andrea, F. Biancari and R. Passariello, "Prospective Comparative Analysis of Colour-Doppler ultrasound, Contrast-enhanced Ultrasound, Computed Tomography and Magnetic Resonance in Detecting Endoleak after Endovascular Abdominal Aortic Aneurysm Repair", vol. 41, Eur J Vasc Endovasc 2011, pp. 186-192.
- [9] B. Collins, J. A. Stoner and G. P.I Digoy, "Benefits of ultrasound vs. computed tomography in the diagnosis of pediatric lateral neck abscesses", vol. 78, International Journal of Pediatric Otorhinolaryngology, 2014 pp. 423–426.
- [10] M. Miniati, S.Monti, E. Airò, R. Pancani, B. Formichi, C.Bauleo and C. Marini, "Accuracy of chest radiography in predicting pulmonary hypertension: A case-control study", vol. 133, Thrombosis Research, 2014, pp. 345–351.
- [11] S. Özkan, "Diyafraam Evantrasyonu ve Cerrahi Tedavisi", Journal of Clinical and Analytical Medicine, , 2014, pp:88-98.
- [12] S.C. Allen, C. Charlton1, W. Backen, M. Warwick-Sanders and P. Yeung, "Performing slow vital capacity in older people with and without cognitive impairment — is it useful?", vol. 39, Age and Ageing, 2010, pp. 588–591.
- [13] Ning Jia, Detecting Human Falls with a 3-Axis Digital accelerometer, Analog Dialogue 43-07, July 2009. [Online].Available:http://www.analog.com/library/analogdialogue/archives/43-07/fall_detector.html, access date: 11/12/2014, time: 11:51 .
- [14] Roetenberg, D., Luinge, H., Slycke, P, "Moven: Full 6DOF Human Motion Tracking Using Miniature Inertial Sensors",

- Xsens Technologies. 2007. [Online]. Available: https://www.xsens.com/images/stories/PDF/MVN_white_paper.pdf, access date: 11/12/2014, time: 11:58 .
- [15] oetenberg, D., Veltink P. H., Slycke, P. J., “Ambulatory position and orientation tracking fusing magnetic and inertial sensing “, IEEE Transactions On Biomedical Engineering, Vol. 54, 2007, No. 5.
- [16] K. Niazmand, I. Somlai, S. Louizi and T.C. Lüth, “Proof of the accuracy of measuring pants to evaluate the activity of the hip and legs in everyday life”, International ICST Conference on Wireless Mobile Communication and Healthcare – Mobihealth, 2010, 18 – 20 October, Ayia Napa, CYRPUS.
- [17] Murat GÜLER, “Giyilebilir Algılayıcılar İle Yaşamsal Verilerin Ölçülmesi ve Görüntülenmesi”, Yüksek Lisans Tezi, İstanbul Teknik Üniversitesi, Fen Bilimleri Enstitüsü, Mekatronik Mühendisliği, İstanbul, 2007.
- [18] A.Priatna, C. B. Paschal, R.G. Shiavi, “Evaluation of linear diaphragm±chest expansion models for magnetic resonance imaging motion artifact correction”, vol. 29, Computers in Biology and Medicine, 1999 pp. 111-127.
- [19] H.Guler and F.Ata, "Tidal Volüm, Solunum Sayısı ve Basınç Değerinin Bulanık Kontrolü" vol. 14, Sakarya Üniversitesi Fen Bilimleri Enstitüsü Dergisi, 2010, pp. 98-105.
- [20] <http://www.meleklermekani.com/threads/diyafiram-nasil-kullanilir.202599/> [Online]. Available access date: 11/12/2014, time: 11:51.
- [21] <http://en.wikipedia.org/wiki/Spirometry> [Online]. Available access date: 11/12/2014, time: 11:51 .
- [22] Torun E., Cakir E., Özgüç F.,Özgen İ.T., “The Effect of Obesity Degree on Childhood PulmonaryFunction Tests”, Balkan Med J 2014;31:235-8