

Design of a Flight Stabilizer for Fixed-Wing Aircrafts Using H_{∞} Loop Shaping Method

Şeyma Akyürek¹, Gizem Sezin Özden¹, Burak Kürkçü², Ünver Kaynak², Coşku Kasnakoglu²

¹TOBB University of Economics & Technology / Electrical & Electronics Engineering, Ankara, Turkey
seymaakyurek@gmail.com, sezin.ozden@gmail.com

²ASELSAN MGEO/Control System Design Department, Ankara, Turkey
bkurkcu@aselsan.com.tr

²TOBB University of Economics & Technology / Mechanical Engineering, Ankara, Turkey
unkaynak@gmail.com

²TOBB University of Economics & Technology / Electrical & Electronics Engineering, Ankara, Turkey
kasnakoglu@gmail.com

ABSTRACT

Autopilot systems for unmanned aerial vehicles (UAVs) and aircrafts provide flight missions without need of human input and make them more reliable and efficient. The first step of designing an autopilot is a stabilizer mode. Conventional autopilot systems have inner and outer loops. Stabilizer is the inner loop for an autopilot. In this paper designing an aircraft control system ensures good performance and robustness that allows control of roll, pitch and yaw angles will be declared. Aircraft dynamics are used to design the model of the control system in the MATLAB Simulink environment. Using loop shaping method to achieve stable and robust control system will be the strategy. Generated controllers to find the most effective one are embedded in the X-plane which is one of the realistic simulations.

Keywords: UAV, aircraft, drone, stabilizer, autopilot, control, loop shaping, H_{∞} .

INTRODUCTION

In recent past, the use of unmanned aerial vehicles has been progressively regnant and significant in several applications related to civil as well as military purposes [1]. Due to their numerous benefits, the control and dynamic modeling of UAVs are becoming the attractive field of research [1]. The use of UAVs in the dangerous positions and grievous situations has reduced the risk of human life. The UAVs are designed for precise missions and maneuvers while an aircraft with pilot is incompatible for it [1].

The early history (1900-1960) of unmanned aerial systems development was sporadic, often taking place when armed conflict required that the military look for new technologies [2]. One of the first methods of controlling an aircraft was mentioned in 1941 by Barbulesco, C. D., in Electrical Engineering Magazine. The problem of remote control of aircraft was initiated at the end of World War I [3]. Two methods have been successfully developed. In the first method the control operator sends into space a definite number of electromagnetic impulses using an ordinary

telephone dial [3]. After that, in 1944 Vincent H. Quayle published another approach for automatic pilot. Autopilots were generated at first, scientists considered the comfort of the passengers before long. Such terms as “relief pilots,” “maneuvering pilots,” “hard or soft pilots,” are used to classify apparatus which accomplishes automatically piloting an aircraft [4]. Performance comes in to play when such terms are combined.

Designing an autopilot can change due to many criteria. The earliest, and most direct, method of analyzing automatic control systems is based on the solution of the differential equations of the system for some initial disturbances [5]. Also controller can be needed in a specific time period or position of the aircraft such as during the cruise. Shull, James Robert discusses this approach in the paper “An Automatic Cruise Control Computer for Long Range Aircraft” in 1952.

Any designing approach will be better if feedback control is added into the system. Feedback control techniques have been applied to automatic flight control problems to produce a new type of automatic pilot [6].

Autopilot systems are the major area of design for UAV's or in general aircrafts. Flight tests are the most comprehensive way of autopilot testing. However due to equipment costs and environmental effects, pre-flight tests is indispensable [7]. Flight stabilizer counteracts disturbance effects and provides a smoother flight pattern compared to manual flight [8].

The aim of this paper is to design control system that allows tracking control of all angles which are roll, pitch, and yaw, while preserving the structure without any surface losses. The control system design for a drone or an aircraft is challenging because of the nonlinear dynamics and strong coupling consisted in the system.

Elevator, aileron, rudder, throttle are used as inputs; speed, theta, beta, phi as outputs when the system is modeled. This approach leads multiple – input – multiple – output system design. The decoupling control of Multi-Input-Multi-Output (MIMO) processes is not a simple

problem [9]. To increase the robustness and to protect the performance as well, a controller with H_∞ loop shaping method is presented. Nonetheless, for the MIMO nonlinear systems, the design of robust flight control is complex for fixed – wing aircrafts with parameter uncertainty, strong nonlinearity, high coupling and unknown external disturbance.

If an airplane is to remain in steady uniform flight, the resultant forces as well as the resultant moment about the center of gravity must both be equal to zero [10]. An airplane satisfying this requirement is said to be in a state of equilibrium of flying at a trim condition [10]. When flight control surfaces are selected as the inputs of the system by trimming and linearizing, nonlinear flight dynamics equations are linearized around this trim condition.

High performance can be efficiently computed by loop shaping controller techniques. These techniques provide stability and robust control system. The H_∞ controllers are suitable for MIMO systems whereas the conventional PID techniques are not [11]. So for the case of PID control alone, the given MIMO plant dynamics are simplified by taking some assumptions such as the consideration of a single dominant input and the absence of interaction among longitudinal states [11].

X-plane simulation is performed to observe results and be satisfactory. It is easy to manipulate, a very realistic flight and also allows for the alteration of various weather conditions.

In this paper, to design a flight controller which ensures good performance and robustness, aircraft dynamic equations being calculated, system modeling and controller designing, H_∞ loop shaping will be explained in order. After these sections are clarified results of the technique will be described in the conclusion and future work section.

AIRCRAFT DYNAMICS

The airplane's behavior following a stall or in a spin shall not include any dangerous characteristics, and that the controls must retain enough effectiveness to ensure a safe recovery to normal flight [12]. Before discuss the stabilizer, creating the system using aircraft dynamics is needed to be mentioned. Flight stabilize controller will be tried in the Carbon – Z Cub N6725Q, an upper wing aircraft model. The reason why Cessna 172's longitudinal and lateral stability coefficients are used is Cessna 172 and Carbon – Z Cub N6725Q have similar specifications.

Two conditions are necessary for an aircraft to manage its mission successfully, first it must be able to achieve equilibrium flight which means aircraft is in uniform motion and it must have the capability to maneuver for a wide range of flight velocities and altitudes. In this study, the very first condition, equilibrium flight, is

considered. Altitude control will be added in upcoming studies as an outer loop.

Control of an airplane can be achieved by providing an incremental lift force on one or more of the airplane's lifting surfaces [10]. The incremental lift force can be produced by deflecting the entire lifting surface or by deflecting a flap incorporated in the lifting surface [10]. Figure 1 shows the three primary aerodynamic controls [10]. Pitch control can be achieved by changing the lift on either a forward or aft control surface [10]. If a flap is used, the flapped portion of the tail surface is called an elevator [10]. Yaw control is achieved by deflecting a flap on the vertical tail called the rudder, and roll control can be achieved by deflecting a small flaps located outboard toward the wing tips in a differential manner. These flaps are called ailerons [10].

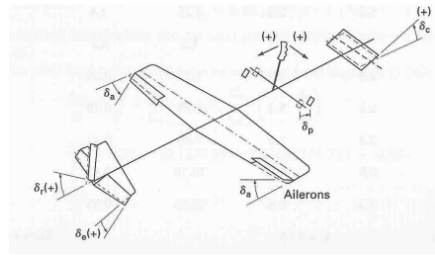

Fig.1. Primary aerodynamic controls [10]

Matlab Simulink has a library called Airlib. In this library there are aircraft model blocks including Cessna 172. Closed loop control system includes the Cessna airlib model block. However when deciding the inner loops, outer loops, how will be the connections, theoretical approximations are crucial. This is the reason not only use Airlib's coefficients but also calculate some necessary ones.

Developing the control system model, full state is the preferred approximation. This means short – period and phugoid dynamics are considered; elevator, aileron, rudder, throttle are determined as inputs of the model. Nevertheless corresponding equations could not be given due to the space limitations. Short – period dynamics will be given shortly though.

SHORT – PERIOD DYNAMICS

The equation with control input from the elevator in state space form can be written as [10]

$$\begin{bmatrix} \Delta \dot{\alpha} \\ \Delta \dot{q} \end{bmatrix} = \begin{bmatrix} \frac{Z_\alpha}{u_0} & 1 \\ M_\alpha + M_{\dot{\alpha}} \frac{Z_\alpha}{u_0} & M_q + M_{\dot{\alpha}} \end{bmatrix} \begin{bmatrix} \Delta \alpha \\ \Delta q \end{bmatrix} + \begin{bmatrix} \frac{Z_{\delta_e}}{u_0} \\ M_{\delta_e} + \frac{M_{\dot{\alpha}} Z_{\delta_e}}{u_0} \end{bmatrix} [\Delta \delta_e] \quad (1)$$

Taking Laplace transform of this equation then dividing these equations by $\Delta\delta_e(s)$ set of algebraic equations in terms of the transfer functions $\Delta\alpha(s)/\Delta\delta_e(s)$ and $\Delta q(s)/\Delta\delta_e(s)$ is obtained [13]. Also solving for $\Delta\alpha(s)/\Delta\delta_e(s)$ and $\Delta q(s)/\Delta\delta_e(s)$ by Cramer's rule yields [10]

$$\frac{\Delta\alpha(s)}{\Delta\delta_e(s)} = \frac{N_{\delta_e}^\alpha(s)}{\Delta_{sp}(s)} = \frac{A_\alpha s + B_\alpha}{As^2 + Bs + C} \quad (2)$$

The transfer function for the change in pitch rate to the change in elevator angle can be shown to be

$$\frac{\Delta q(s)}{\Delta\delta_e(s)} = \frac{N_{\delta_e}^q(s)}{\Delta_{sp}(s)} = \frac{A_q s + B_q}{As^2 + Bs + C} \quad (3)$$

Short – period transfer function approximations are given in the Table 1.

Table 1. Short – period transfer function approximation [10].

	A, A_α or A_q	B, B_α or B_q	C
$\Delta_{sp}(s)$	1	$-(M_q + M_{\dot{\alpha}} + \frac{Z_\alpha}{u_0})$	$\frac{Z_\alpha M_q}{u_0} - M_\alpha$
$N_{\delta_e}^\alpha(s)$	$\frac{Z_{\delta_e}}{u_0}$	$M_{\delta_e} + \frac{M_q Z_{\delta_e}}{u_0}$	
$N_{\delta_e}^q(s)$	$M_{\delta_e} + \frac{M_{\dot{\alpha}} Z_{\delta_e}}{u_0}$	$\frac{M_\alpha Z_{\delta_e}}{u_0} - \frac{M_{\delta_e} Z_\alpha}{u_0}$	

Table 2. Cessna 172 stability coefficients and derivatives.

u_0 = 196.8	Z_{δ_e} = -48	M_{δ_e} = -37	M_α = -26	$M_{\dot{\alpha}}$ = 0	Z_α = -580
M_q = -4.504	A_q = -37.34	B_q = -103.62	A = 1	B = 7.45	C = 39.23

The nonlinear equations of motion for an aircraft were used, but the aerodynamic coefficients were held constant [13].

Cessna 172's stability coefficients and derivatives are given in the Table 2. In steady horizontal longitudinal flight, the aircraft is assumed to fly at constant velocity $u = u_0$ to simplify the aerodynamic analysis [14]. This choice is universally made in the literature [14]. The transfer function for the change in pitch rate to the change in elevator angle becomes

$$\frac{\Delta q(s)}{\Delta\delta_e(s)} = \frac{-37.34(s + 2.775)}{s^2 + 7.45s + 39.23} \quad (4)$$

Table 3 Transfer function of equation (4) poles and zeros.

Poles	Zeros
$-3.725 \pm 5.0353i$	-2.775

In the real flight, every factor causes nonlinearity. Instead of nonlinear system, linear systems are so much easier to be modeled. Simulink model is generated as a nonlinear system. MATLAB offers a mode to linearize the system. To prove each linear system, calculated by the theory and Simulink model are similar, poles and zeros should be checked.

Table 4. The linear system's, which linearize by MATLAB , poles and zeros.

Poles	Zeros
$-3.7041 \pm 4.9509i$	-2.7594
$-0.015196 \pm 0.19102i$	-96.668
-12.879	-0.0003451
$1.9229 \cdot 10^{-6}$	
$-0.72361 \pm 3.1856i$	
-0.012651	
-10	
-10	
-10	

Transfer function of the equation 4's poles and zeros are the same with poles and zeros given in the Table 4's first row. This indicates, Simulink model has the similar approximation with pitch rate to the change in elevator angle as the theory.

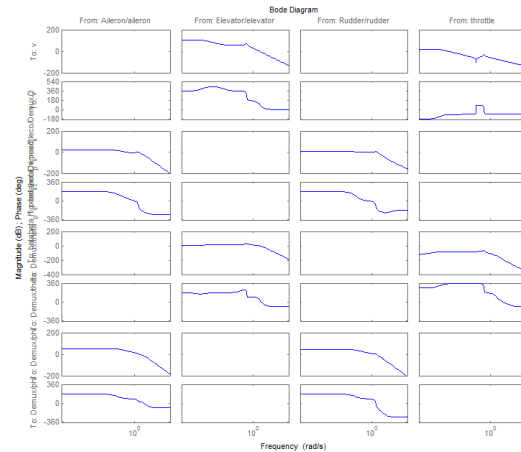

Fig.2. Bode diagram of the linear system

SYSTEM MODELLING AND CONTROLLER DESIGN

There are lots of approaches to control an aircraft or UAV. Some of these concepts offer some substantial aerodynamic performance advantages but also have significant aerodynamic and inertial cross-coupling between the aircraft longitudinal and lateral-directional axes [15]. As mentioned earlier, there are couplings between aircraft's control surfaces, such as rudder and aileron. Rudder's angle psi and aileron's angle phi can affect each other. This affection can be used favor of the system however it can

cause damage. The decoupling control of Multi-Input-Multi-Output (MIMO) processes is not a simple problem [16]. Modeled MIMO system is shown in the Figure 3. Controller will be created by considering this model. The model showed in the Figure 3 is a nonlinear system with couplings. Generated controller should work at any condition, and should not be affected from any couplings.

When linearization and trimming methods are done to obtain a linear system using H_∞ loop shaping method a robust and good performance controller is generated.

As it can be seen in the Figure 6, 7, 8 controller successfully managed the command for every reference

values. Phi reference angle's given as 5 degrees can be seen in the Figure 3. Result of this command is in the Figure 8, third graphic, phi angle settles in 5 degrees in less than 5 seconds and without any oscillation. It can be given as an example. Other corresponding results will be mentioned in the section called conclusion and future work.

H_∞ loop shaping method is used to obtain a robust controller with good performance. This paper presents a technique for designing a controller to achieve robust performance for a plant that is linear, unstable and minimum-phase.

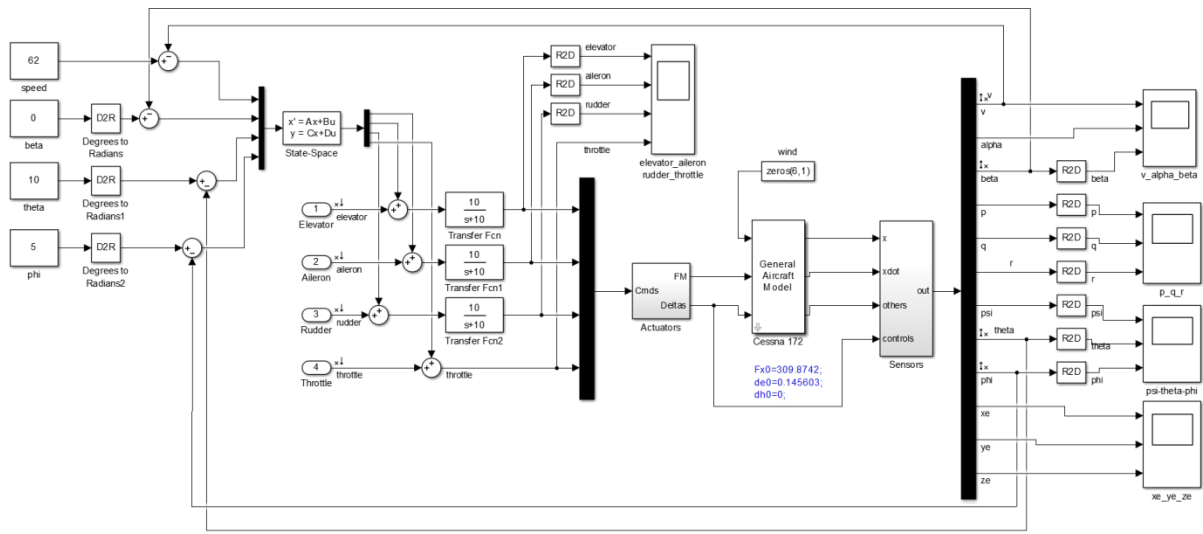

Fig.3. MIMO system model with the controller

H_∞ LOOPSHAPING

In this section, a MIMO control system that is formed of H_∞ solution is designed.

First step of designing controller is computation of a stable and minimum phase loop-shaping. Furthermore, square-down prefilter W . This prefilter must satisfy a square matrix of shaped plant where shaped plant $G_s = GW$. In addition, equation 5 must be satisfied.

$$\sigma(G_d) \approx \sigma(G_s) \quad \forall w \quad (5)$$

This methodology can be obtain by using GCD formulas that introduced by Safonov [17].

On the other hand, normalized coprime factor synthesis theory is used to compute an optimal loop-shaping controller for shaped plant. For coprime factorization, it is given some necessary definitions;

$$G = M^{-1}N \quad (6)$$

Then any perturbed plant can be written as

$$G_\Delta = (M + \Delta_M)^{-1}(N + \Delta_N) \quad (7)$$

where Δ_M and Δ_N are stable and unknown transfer functions that presents uncertainties in the nominal plant. The objective of the robust controller design is that stabilize by a controller K not only nominal plant but also the family of perturbed plant defined in Equation 8.

$$G_\varepsilon = \{(M + \Delta_M)^{-1}(N + \Delta_N) : \|\Delta_M, \Delta_N\|_\infty < \varepsilon\} \quad (8)$$

For robust stability, the internal stability must be achieved for nominal and perturbed plant. Further, if there exist such a K that (M, N, K, ε) is robustly stable, then (M, N, ε) is said to be robustly stabilizable with stability margin ε [18]. For robust stability Equation 9 and Equation 10 must be satisfied.

$$(I - GK)^{-1}, K(I - GK)^{-1}, (I - GK)^{-1}G, (I - KG)^{-1} \in RH_\infty \quad (9)$$

$$\det(I - GK)(\infty) \neq 0$$

$$\inf_K \left\| \left\| \begin{bmatrix} K(I - GK)^{-1}M^{-1} \\ (I - GK)^{-1}M^{-1} \end{bmatrix} \right\| \right\|_\infty \leq \varepsilon^{-1} \quad (10)$$

where infimum is chosen over all stabilizing controller K . The H_∞ optimization problem allows ε^{-1} being chosen as small as possible. The robust stabilization problem can be converted to Doyle formulation. Let

$$P \triangleq \begin{bmatrix} P_{11} & P_{12} \\ P_{21} & P_{22} \end{bmatrix} = \begin{bmatrix} 0 & (I) \\ M^{-1} & G \\ M^{-1} & G \end{bmatrix} \quad (11)$$

Then Equation 10 is equivalent to Equation 12.

$$\inf_K \|L(P, K)\|_\infty \leq \varepsilon^{-1} \quad (12)$$

where K is chosen as all stabilizing controller and P is standard plant for H_∞ optimization problem.

Standard solution of the above problem expressed in [19].

In addition, final express for designed controller is given by Equation 13.

$$K_{final} = WK \quad (13)$$

As a solution for given plant for this paper, sensitivity, complementary sensitivity, desired shape and achieved shaped diagrams are given in Figure 4. Furthermore, step responses for MIMO system is given in Figure 5.

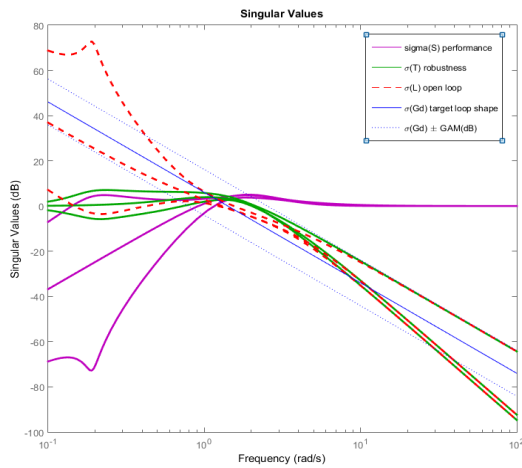

Figure 4. Sens, Comp Sens, Desired Shape, Achieved Shaped

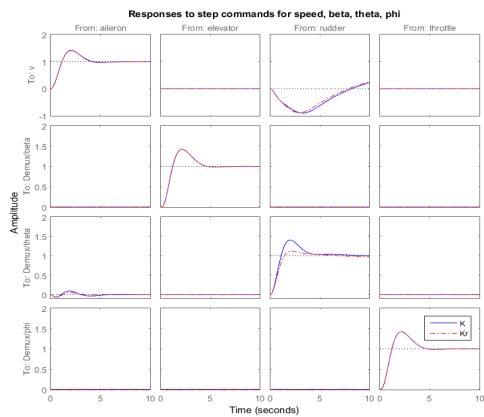

Figure 5. Step responses for MIMO system

CONCLUSION AND FUTURE WORK

In this paper, one design approach of a flight stabilizer for fixed wing aircrafts using H_∞ loop shaping method and tested in Xplane flight simulation are outlined. The flight stabilizer's controller worked successfully. It can be seen in the Figure 6, 7, 8 easily.

Beta side slip angle input is given as 0 degree in Figure 3. Its result which can be seen in the Figure 7, settles to 0 degree in 5 seconds. Theta, that is pitch angle, input is given as 10 degrees in Figure 3. Its result that is given in Figure 8, settles to 10 degrees in 5 seconds. Phi roll angle input is given as 5 degrees in the Figure 3. Its result that can be seen in the Figure 8, settles to 5 degrees in 4 seconds. Speed input is given as 62 m/s in the Figure 3. 60 m/s is the initial condition when the model is trimmed and linearized. Speed increases from 60 m/s to 62 m/s in 5 seconds in Figure 7.

In the given figures, there are other angles that are affected by the given commands. This issue occurs due to couplings. For instance psi angle has changed despite the fact that there is no given input command to psi. However, there is an input for phi angle, and psi's change has influence on psi which means as the aircraft turns, psi and phi angles are going to change. The coupling situation can be a problem or used for the benefit of the aircraft.

In future work, psi control will be added as an outer loop to the system model. This way coupling between psi and phi can be obstruct.

In addition to the future work, altitude controller will be added in the model as an outer loop as well. Also surface loss scenarios are considered and controller will be developed based on this work to eliminate the impact of these losses.

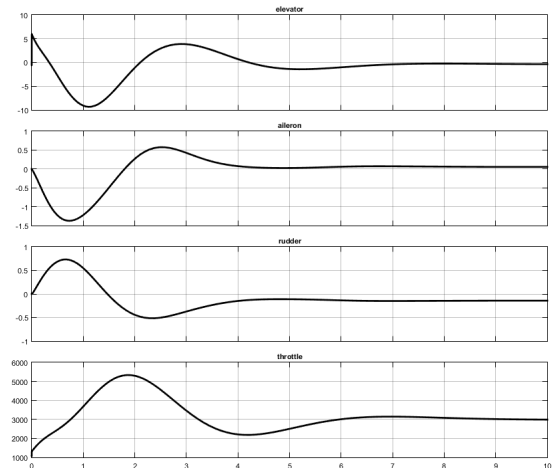

Fig.6. Simulation results for elevator, theta, rudder, throttle.

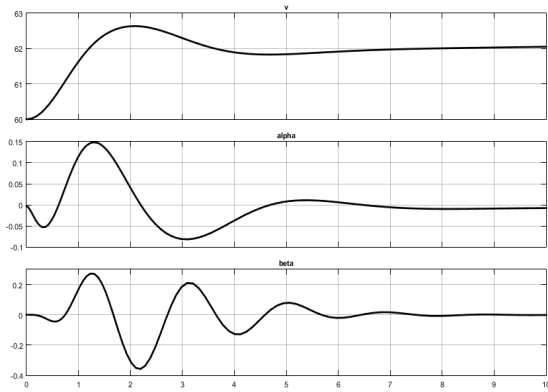

Fig.7. Simulation results for speed, alpha, beta.

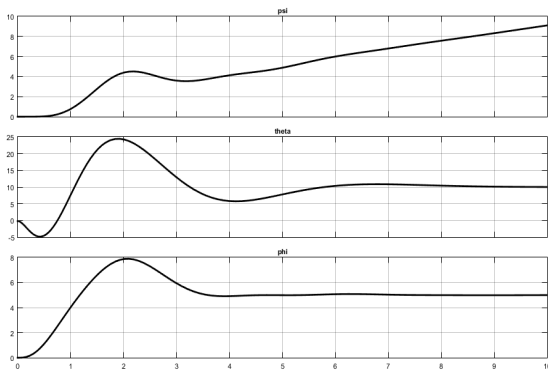

Fig.8. Simulation results for psi, theta, phi

REFERENCES

- [1] M. Z. Babar, S. U. Ali, M. Z. Shah, R. Samar, A. I. Bhatti and W. Afzal ; "Robust Control of UAVs using H Control Paradigm " Emerging Technologies (ICET), 2013 IEEE 9th International Conference
- [2] Carr, E.B., Unmanned Aerial Vehicles: Examining the Safety, Security, Privacy and Regulatory, Issues of Integration into U.S. Airspace
- [3] Barbulesco, C. D., Automatic Control of Aircraft, Electrical Engineering, 1941, Volume 60 Issue 3
- [4] Young, C. M., Lynch, E.E., Boynton, E.R., Electrical Control in Automatic Pilots, Electrical Engineering, 1944, Volume 63, Issue 12
- [5] Nims, P.T, Some Design Criteira for Automatic Controls, Electrical Engineering, 1951, Volume 70, Issue 5
- [6] Hanna, C.R., Oplinger, K.A., Douglas, G.R., Automatic Flight Control System Using Rate Gyros for Unlimited Maneuvering, Electrical Engineering, 1954, Volume 73, Issue 5
- [7] Santos, S.R.B.; Oliveira, N.M.F. , "Test platform to pitch angle using hardware in loop," Frontiers in Education Conference, 2009. FIE '09. 39th IEEE, vol., no., pp.1-5, 18-21 Oct. 2009.
- [8] Korkmaz, H., Ertin, O.B., Kasnakoglu, C., and Kaynak, Ü., Design of a Flight Stabilizer System for a Small Fixed Wing Unmanned Aerial Vehicle Using System Identification. Advances in Control and Automation Theory for Transportation Applications (ACATTA 2013), Istanbul, Turkey on September 16-17, 2013
- [9] Keviczky, L., Bányász, Cs., MIMO Controller Design for Decoupling Aircraft Lateral Dynamics, 2011, 9th IEEE International Conference on Control and Automation (ICCA), Santiago, Chile.
- [10] Nelson, R.C., Flight Stability and Automatic Control, Second Edition, McGraw-Hill International Editions, 1998
- [11] Johnson, Y.; DasGupta, S.; "Control and tracking of longitudinal dynamics of UAVs in synchronized motion" Control Communication and Computing (ICCC), 2013 International Conference
- [12] Etkin, B., Reid, L.D., Dynamics of Flight Stability and Control, Third Edition, John Wiley & Sons Inc. 1996
- [13] Schumacher, C.J., Kumar, R., Adaptive Control of UAVs in Close-Coupled Formation Flight, Proceedings of the American Control Conference, Chicago, Illinois, June 2000
- [14] J. Roskam, Airplane Flight Dynamics and Automatic Flight Controls. Wichita, KS: DARcorporation, 2001
- [15] Alag, G.S., Kempel, R.W., Pahle, J.W., Decoupling Control Synthesis for an Oblique-Wing Aircraft, June 18-20, 1986, American Control Conference
- [16] Keviczky, L., Bányász, Cs., MIMO Controller Design for Decoupling Aircraft Lateral Dynamics, 2011, 9th IEEE International Conference on Control and Automation (ICCA), Santiago, Chile
- [17] Le, V.X., and M.G. Safonov. Rational matrix GCD's and the design of squaring-down compensators-a state space theory. IEEE Trans. Autom.Control, AC-36(3):384-392, March 1992.
- [18] M. Chen and C. Desoer, "Necessary a?d sufficient for robust stability of linear distributed feedback systems, Int. J. Contr., vol. 35, pp.255-267,1992
- [19] Glover, K., and D. McFarlane. Robust stabilization of normalized coprime factor plant descriptions with H_∞ -bounded uncertainty. IEEE Trans. Autom. Control, AC-34(8):821-830, August 1992.