

Cooperation scheme between KNX and a microgrid control system for enhanced demand-side management

D. Stimoniaris¹, T. Kollatou¹, D. Tsiamitros¹, K. Gavros¹, V. Kikis¹, S. Asimonis², M. A. Zehir³, A. Batman³, M. Bagriyanik³, A. Ozdemir³, and E. Dialynas⁴

¹Dept. of Electrical Engineering, Technological Educational Institute of Western Macedonia, Kozani, GREECE

dtsiamit@teiwm.gr

² Dept. of Physics, Aristotle University of Thessaloniki, Thessaloniki, GREECE

assimonis@gmail.com

³ Dept. of Electrical Engineering, Istanbul Technical University, Istanbul, TURKEY

ozdemiraydo@itu.edu.tr

⁴ Dept. of Electrical and Computer Engineering, National Technical University of Athens, Athens, GREECE

dialynas@power.ece.ntua.gr

Abstract

Renewable Energy Sources (RES) plants still have to operate at their maximum possible output and are therefore independent of electric energy consumption. Thus, coordination between distributed generators, energy storage systems and flexible loads is expected to add a great value to grid operations and facilitate further RES penetration. Increasing penetration of home automation technologies at the demand-side and their control possibilities over energy consumption may also make valuable contributions to the grid operation. Thus, the control system of the future grid should be compatible with home automation systems. This paper presents a simple technique that enables home automation technologies to be used for demand-side management in smart grids. The proposed technique does not require additional interface or software tools and therefore is cost-effective. Experimental results prove that these technologies could contribute to the voltage regulation as well as to the application of efficient energy management policies of microgrids.

1. Introduction

Sustainable generation is scheduled in accordance to the estimated load levels as well as to some technical and economical restrictions. However, weather-dependent RES, such as PV-plants and wind-farms, have to operate at their maximum possible output whenever technically possible, in order to present high participation of RES to the electric energy production mixture. Whenever local or isolated energy networks are considered (e.g. islands), these operational principles cannot be achieved and include the risk of leading to insufficient energy supply. All the problems stated above can be overcome through the integration of energy storage systems and controllable loads to the grid and through the integration of improvements to the control infrastructure and algorithms in non-invasive for the distribution network manner.

One of the most important parts of the future electricity grid topologies seems to be the microgrid, which is generally defined as a distribution grid including Distributed Generators (DGs), energy storage units and controllable loads [1]. The ancillary services that could be provided by the supply-side and the

demand-side of a microgrid are expected to increase the value of the future smart grid [2], [3]. Load levelization and demand-side management are extensively used in general to provide services like voltage regulation and energy management for islanded microgrids [3], [4]. At the same time, the implementation of home automation systems at the demand-side will continuously increase in the near future, due to the need for energy efficiency upgrade in buildings [5]-[7]. A worldwide standard for home and building automation is KNX [5]. Many companies prefer to manufacture KNX compatible devices, such as dimmers, sensors, metering devices, meteorological stations, etc. These certified automation devices are installed usually at the low-voltage part of the grid and have many capabilities in controlling electric energy consumption, since they are programmable. Their operation is based on a common data bus, through which simple binary signals can be transmitted for the activation of their various capabilities.

During islanded operation of microgrids, accurate estimation and proper management of the State of Charge (SoC) of energy storage systems are very important [8], [9]. In [10] it is shown that the improper control infrastructure and algorithms could affect grid operation negatively, leading to inaccurate SoC estimation as well as degradation of power supply reliability of customers. Therefore, it is clear that control infrastructure of a smart distribution grid should be compatible and properly interactive with energy storage systems and existing home automation technologies.

This paper describes the control infrastructure and algorithm of an experimental smart microgrid [11] and KNX home automation system [5] that are combined in a very simple and cost-effective manner in order to achieve an optimal demand-side management. In the first section, the smart microgrid topology is described by highlighting its innovative control infrastructure parts which transform the distribution network to a "smart grid". Then, a brief description of the control algorithm of a microgrid is presented, together with options for interoperability to home automation systems. In the next section, details of the proposed simple technique that integrates the home and building automation devices into the microgrid are highlighted. Finally, experimental results of microgrid operation are presented. The results revealed that the incorporation of home automation systems could significantly improve supply/demand balance of the microgrid and consumer reliability performance.

2. Microgrid topology

2.1. Description of the control infrastructure

In a microgrid-based smart distribution grid topology, every DC load, generator or energy storage device is equipped with individual DC-AC inverters and is connected to the AC microgrid via smart devices called special control units (SCUs). SCUs are also necessary for AC loads (or group of loads) and generators as well. Each SCU consists of a simple metering module, a communication module, an activation module (actuator) and a “smart” module that is responsible for the decision making task. The last module is integrated into software that runs on a microgrid-dedicated PC. This topology is implemented at the facilities of the Technological Educational Institute of Western Macedonia (TEIWM) [11].

The microgrid consists of two PV-inverters of 1.1 kW each, with 6 connected PV panels each, five loads of approximately 2600 W maximum consumption (1 AC-motor, incandescent and fluorescent lamps and a fridge), a 600 Ah-24 V battery bank with its inverter and a wind generator of 1 kWp with its rectifier-charger. Ten SCUs are required as follows:

- Two for the PV plants.
- Five for the loads.
- One for the battery bank.
- One for the wind generator.
- One for the interconnection to the remaining grid.

In this experimental microgrid, each SCU contains a metering module with one current transformer (CT) and one voltage transformer (VT), an activation module with one actuator-relay and a communication module that consists of a Data Acquisition Card (DAQ: NI-USB-6008) and is connected with the microgrid-dedicated PC via cables. However, due to the common AC bus, only one AC VT is required for the microgrid’s bus, one AC VT for the measurement of the voltage of the remaining grid and one Data Acquisition Card set. The laboratory set-up is shown in Fig.1, where a home automation device will be implemented at the encircled part. A DC Voltage Divider (VD) is connected in parallel to the battery bank, although it is not shown in the topology of Fig.1, for DC-voltage measurements. The microgrid-dedicated PC incorporates a software application in LabVIEW that processes the input data and the control algorithm written in MATLAB, while it derives the proper output commands at every duty-cycle.

2.2. Interoperability with Home Automation System

In order to incorporate home automation technology into real-time measurements and decision systems in general, an OPC (OLE – Object Linking and Embedding- for Process Control) server software is needed. In the case of the experimental microgrid, except a KNX device and a KNX-Ethernet Interface, a KNX OPC server should be also installed at the microgrid-dedicated PC, as shown in Figure 2. Load 5 in Fig. 2 is the motor and Load 4 is a 500 W incandescent lamp group.

The above methodology has the following serious disadvantages, most of which are encountered in the implementation process:

- The KNX OPC server software installed on the computer where the LabVIEW application runs has a fairly high cost.
- Permanently installed KNX-Ethernet gateway also has a high cost but can be used for many other KNX applications.

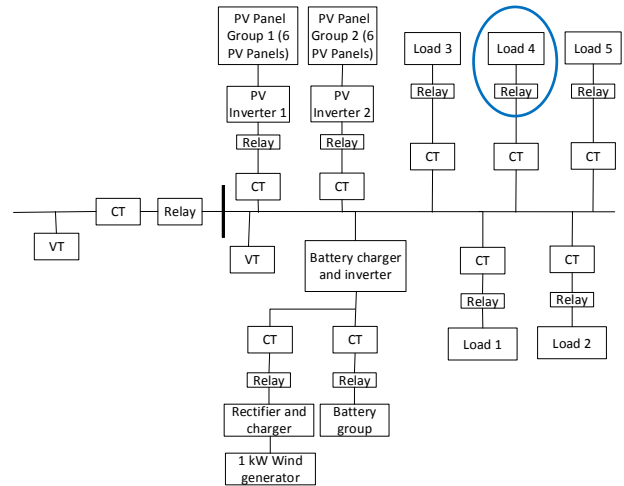

Fig. 1. Implementation of a smart distribution grid topology (TEIWM microgrid)

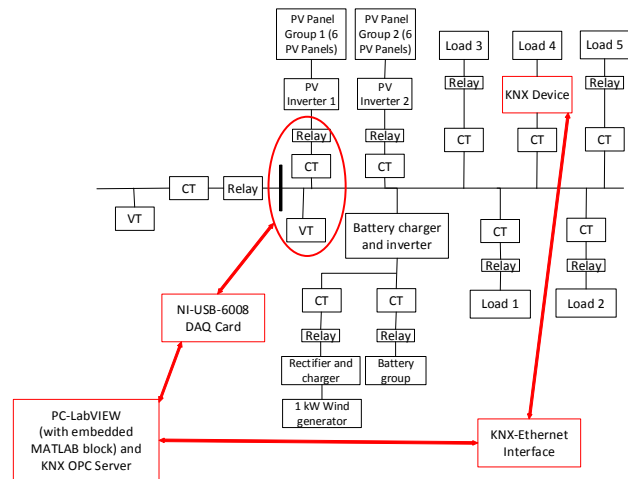

Fig. 2. Interoperability with the KNX

iii) The process of connecting the two software applications (LabVIEW as a client of the KNX OPC server) is quite difficult. More specifically, additional tools are required, such as the Datalogging and Supervisory Control (DSC) Module in LabVIEW, which also increase implementation costs. Moreover, several problems of compatibility occur, such as the continuous upgrade of the ETS software [5], without the follow up of the KNX OPC server.

All these problems have led the authors to seek simple and economic alternative solutions. Consequently, the connection of the microgrid’s control software with the KNX technology that is presented in the following section was preferred.

3. Description of the LabVIEW application, the iterative control algorithm and KNX interoperability

3.1. LabVIEW Application

The developed LabVIEW application is responsible for the following tasks [11]:

- Data sampling and transformation of voltage and current measurements into RMS values at each duty-cycle.

- Calculation of other electric parameters (active and reactive power, frequency, etc).
- Incorporation of the control algorithm written in MATLAB code.
- Data recording.
- Transmission of the commands derived by the control algorithm to the digital output of the DAQ card.

3.2. The Iterative Control Algorithm

The control algorithm consists of two major parts [11]:

1. Real-time voltage and frequency surveillance and correction, in cooperation with the distribution grid. This part is responsible for the fast active and reactive power compensation, in order to contribute to the voltage and frequency regulation.
2. The energy storage management strategy, which consists of the SoC estimation routine and the respective DGs and load management actions. This part of the algorithm is presented in detail in Section IV.

4. Details on the cost-effective demand-side management application

4.1. Description of the Energy Storage Management Strategy that incorporates home automation systems.

The energy storage management strategy involves the measurement of the DC voltage and current of the batteries, takes into account the previous SoC values and the DGs' power production and proceeds to more targeted control actions [11]. More specifically, during the duty-cycle of the LabVIEW application, each RES's power production and each load's consumption are measured separately, together with the battery voltages and currents. The voltage-current characteristic curves of lead-acid batteries that correspond to 60%, 40% and 25% SoC are presented in Fig. 3. The normalized current and voltage values of batteries are compared to the characteristic curves. They may fall into four "SoC areas": Area-1, Area-2, Area-3 and Area-4 correspond to above 60% characteristic, between 60% and 40% characteristics, between 40% and 25% characteristics and below the 25% characteristic, respectively. Then, the actual SoC (SoC_i) is determined [11]. After determining the SoC, the following DGs and load management actions are taken:

1. In a discharging situation (SoC reduction), one or more active loads of the microgrid are switched off, starting from the least critical load.
2. If the batteries are charging, previously switched off loads, if any, are switched on gradually, starting from the most critical inactive load.

The above DG and demand-side management strategy is described in more detail in [11].

When a KNX device is integrated into the microgrid, as shown in Fig. 2, instead of rejecting the loads, starting from the least critical one, power supply of the KNX load can be controlled as follows:

- 1) In case of SoC reduction, consumption of the KNX load can be reduced from the control algorithm, to a level, previously set by the KNX device's program.
- 2) In case of SoC increase, the consumption of the KNX load can be increased from the control algorithm, to a level, previously set by the device's program.

The results show that none of the loads are totally rejected when KNX automation system is used for load control actions instead of traditional on-off control.

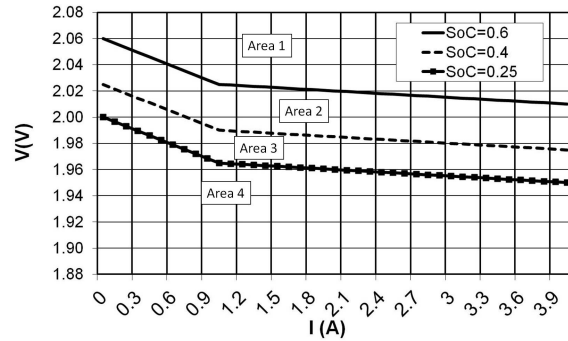

Fig. 3. Voltage-current characteristics of lead-acid batteries for different SoC values

4.2. Cost Effective Demand-side management based on home automation technologies.

As already mentioned in Section III, a simple and inexpensive alternative solution is developed for the integration of KNX-compatible load control devices to the microgrid control strategy. Most of the KNX-compatible load control devices are activated through KNX switches as well as by conventional push buttons, whose manipulations can be translated into binary signals. In a KNX dimmer for example, when the push button is pressed shortly, the signal is translated into a pulse in the dimming device. The device's embedded KNX program translates this pulse to full power of the lamps and the lamps consume full power. On the other hand, prolonged pressure of the switch means that the KNX device sequentially receives 1 bit signals. In this case, the device starts reducing the voltage of the lamps until pressing ends or until the voltage is dimmed down to the final value set by the original program of the dimmer. Respectively, the lighting and the power consumption are reduced. If then the button is being pressed for a long time the brightness is increased and so on.

The proposed approach is based on replacing or parallelizing a dimmer's push button with the relay of Load 4, in order to control the lamps. The dimming signals are sent to the KNX dimmer by the relay under the control of the LabVIEW application. More specifically, the encircled part in Fig. 1 is replaced by the setup shown in Fig. 4. In this figure, the L and N are the phase and neutral connections of the AC bus of the microgrid. They are placed after the CT of Load 4. So all the disadvantages faced during the implementation of the previous KNX integration method are eliminated.

In Fig. 4, on the left side of the KNX dimmer the pair of KNX cables (black and red colors) are shown that form the KNX bus and are connected to the KNX power supply (30 V). The connection to the AC microgrid is shown on the right side and includes one input that is connected to the lamps, another input is connected to the phase (L) of the AC microgrid and the third input is connected to the relay, which in turn is also connected to the supply phase. The last input is the common neutral node of the AC microgrid and the lamps.

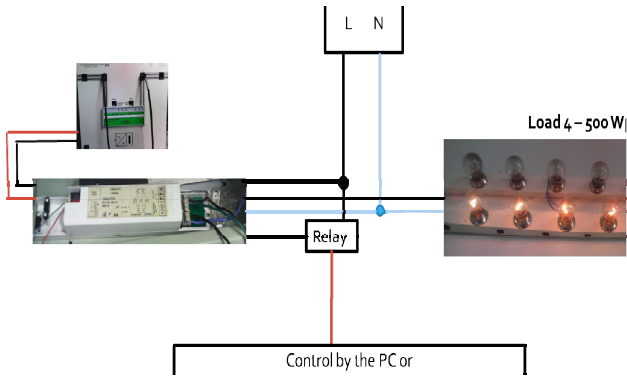

Fig. 4. The simple KNX arrangement that replaces the encircled part in Fig. 1

Similar to the push button application, the instantaneous switching on and off of the relay is transformed to a pulse in the dimming device, which is equivalent to full power supply to the lamps by the program of the KNX device. So the lamps are on and consume full power. Prolonged position of the relay at the value of 1, means that the KNX dimmer sequentially receives 1 bit signals. Then the dimmer starts reducing the voltage of the lamps until the relay is deactivated or until the value that is set by the original program. The lighting and the consumed power are reduced respectively. If the relay's actuation is repeated, the dimming device starts increasing the brightness. In Fig. 5, the active power consumption during the activation of the relay and therefore the dimmer is shown.

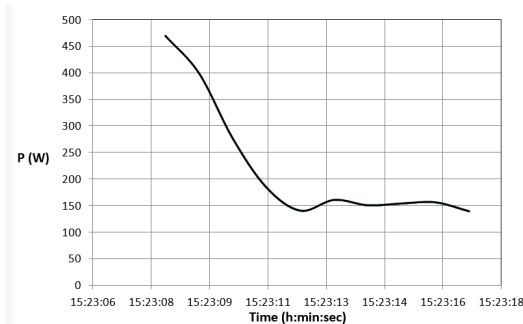

Fig. 5. Active Power Consumption during dimming

5. Experimental Results

The KNX-controlled loads can be utilized to perform primary (event-based) control actions in response to voltage and frequency deviations to ensure that frequency and voltage remain close to their set point values [2]. As also observed experimentally, in microgrids without rotating generators and with R/X ratio higher than 2 (like the one presented here), the voltage level depends on the active power balance [3], [4]. In this case the KNX load acts as an active load, based on the grid voltage [4], without the need of establishing communication with the microgrid's LabVIEW control application. Another way for the home and building automation technology to contribute to quick recovery of the voltage or frequency and many other events occurring on a microgrid (such as increasing self-consumption, improving the usage of renewable, etc.) is the activation of the relay and, consequently, the dimmer by establishing communication to the LabVIEW application.

Because of incorporating microgrid control logic, the latter approach widens the possible application areas. Finally, KNX devices' performance is tested for efficient energy management policy of an isolated microgrid, as described in Section 4.A.

5.1. Primary (Event-Based) control with the dimmer (without communication with the LabVIEW application).

In order to contribute to the quick recovery of the voltage of the AC-bus or the frequency of a microgrid, the home automation technology can be combined with one appropriate methodology and that is the activation of the relay and consequently the dimmer when a large load is connected. The aim is to reduce the negative impact of the large load connection that results in high voltage drops in the network. This action is implemented if the relay of the KNX dimmer is controlled by a voltage supervising device. The voltage profiles are shown in Fig. 6, by considering or ignoring the activation of the KNX devices. The recording of the measurements starts when dimming is activated, in order to assist the comparison. It is clear that the usage of home and building automation control enabled the voltage to restore quickly to 230 V and shortened the duration of immersion of the voltage.

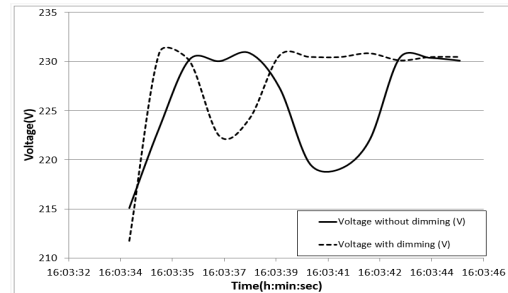

Fig. 6. Comparison of voltage profiles for the AC-bus of the microgrid

5.2. Primary control with the dimmer (through communication with the LabVIEW application)

One way for the KNX technology to contribute to quick recovery of the voltage of the AC-bus or the frequency of a microgrid is the activation of the relay and consequently the dimmer by the LabVIEW software. So, once the LabVIEW application detects a voltage drop greater than specified limits, it activates the relay and the dimming device in the next execution cycle (duty-cycle). The results are shown in Fig. 7. It is obvious that the durations of voltage dips are shorter and get shallower after the dimmer activation.

5.3. Efficient energy management of an isolated microgrid with Home Automation Technologies

In this application, KNX devices are used for the implementation of an efficient energy management policy of an isolated microgrid, as described in Section 4.A. So, when the LabVIEW-MATLAB control software determines that the battery charge level (State of Charge - SoC) is reduced, it stops rejecting the loads. On the contrary, it activates the relay of Figure 4 and the active power consumption of Load 4 is reduced. The battery voltage and discharge current change while

the microgrid battery charge level is improved, as shown in Fig. 8.

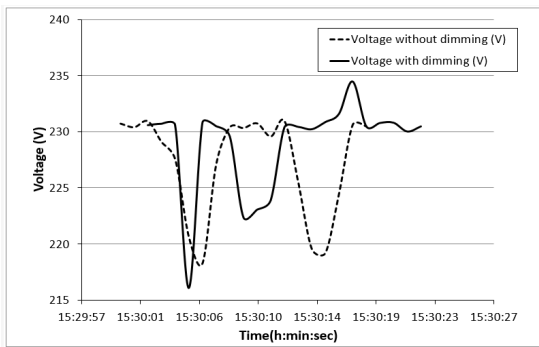

Fig. 7. Comparison of voltage profiles for the AC-bus of the microgrid

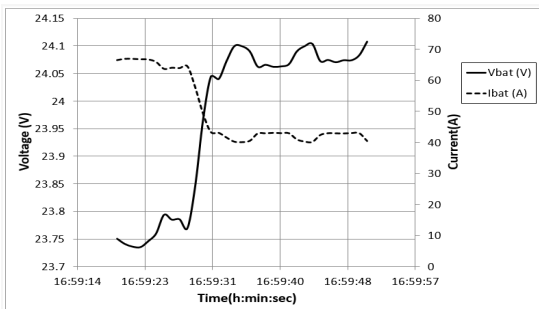

Fig. 8. Batteries' voltage and discharge current before and after dimming.

6. Conclusions

In this paper, an event-based control, an improved energy storage management strategy and a home automation system are combined based on a demand-side management approach in order to improve the reliability performance of the power supply in an experimental microgrid. The operation of the microgrid with the SCUs' control infrastructure and the iterative control algorithm are compared with a microgrid including SCUs and KNX devices, by taking into account the supply reliability performance. The experimental results include the utilization of KNX-controlled loads for performing primary (event-based) control actions in response to voltage and frequency deviations, with and without establishing communication with the microgrid's control application and for the implementation of an efficient energy management policy. The results show that by activating home automation devices, the durations of voltage dips are shorter and get shallower, whereas energy storage is much more efficiently used.

7. Acknowledgements

The described work is funded by the "Smart Electric Energy Management and Buildings Energy Efficiency Technologies – SEEMBEET" project, which is executed in the framework of the "Bilateral Research and Technology Cooperation Greece-Turkey 2013-2014", which is co-financed by the European Union and the Greek State, Ministry of Education and Religious Affairs / General Secretariat for Research and Technology (O. P. Competitiveness & Entrepreneurship (EPAN II), ROP Macedonia - Thrace, ROP Crete and Aegean Islands, ROP Thessaly - Mainland Greece - Epirus, ROP Attica)" and "The

Scientific and Technological Research Council of Turkey (TUBITAK)".

8. References

- [1] Laaksonen, K. Kauhaniemi, S. Voima, "Microgrid Voltage Level Management and Role as Part of Smart Grid Voltage Control", IEEE PowerTech2011, Trondheim, Norway, 2011.
- [2] K. De Brabandere, K. Vanthournout, J. Driesen, G. Deconinck, R. Belmans, "Control of Microgrids", IEEE Power Engineering Society General Meeting, 2007.
- [3] A. P. Meliopoulos, G. Cokkinides, R. Huang, E. Farantatos, S. Choi, Y. Lee, X. Yu, "Smart Grid Technologies for Autonomous Operation and Control", IEEE Transactions on Smart Grids, vol. 2, Iss. 1, pp. 1-10, 2011.
- [4] T. L. Vandoom, B. Renders, L. Degroote, B. Meersman, L. Vandeveld, "Active Load Control in Islanded Microgrids Based on the Grid Voltage", IEEE Transactions on Smart Grids, Vol. 2, Iss. 1, pp. 139-151, 2011.
- [5] KNX- The International buildings control and automation standard, www.knx.org.
- [6] D. Tsiamitros, D. Stimoniaris, N. Poulakis, M. A. Zehir, A. Batman, M. Bagriyanik, A. Ozdemir and E. Dialynas, "Advanced Energy Storage and Demand-Side Management in Smart Grids using Buildings Energy Efficiency Technologies", IEEE Innovative Smart Grid Technologies 2014 Conference (IEEE-ISGT2014), Istanbul, Turkey, 12-15 October 2014.
- [7] T. Kollatou, D. Tsiamitros, D. Stimoniaris, V. Kikis, M. A. Zehir, A. Batman, M. Bagriyanik, A. Ozdemir and E. Dialynas, "Advanced Demand-Side Management in Microgrids using KNX Technologies", 2014 KNX Scientific Conference, Wiesbaden, Germany, 30-31 October 2014.
- [8] S. Piller, M. Perrin, A. Jossen, "Methods for state-of-charge determination and their applications," Journal of Power Sources, vol. 96, pp. 113-120, 2001.
- [9] Sunny Island Installation Guide, Version 4.0, [Online]. Available: <http://www.sma.de>.
- [10] D. Stimoniaris, D. Tsiamitros, N. Poulakis, T. Kottas, V. Kikis, E. Dialynas, "Investigation of Smart Grid Topologies Using Pilot Installations-Experimental Results," IEEE-ISGT-2011, Manchester, UK, 2011.
- [11] D. Stimoniaris, D. Tsiamitros, E. Dialynas, "Improved Energy Storage Management and PV-Active Power Control Infrastructure and Strategies for Microgrids," IEEE Transactions on Power Systems, D.O.I.: 10.1109/TPWRS.2015.2389954, IEEE early access articles.